

Pandora would like to thank you
for choosing our service-security system
for motorcycles Pandora Smart Moto/Smart Moto Plus

Pandora Smart Moto / Smart Moto Plus is a service-security system built for motorcycles and quads with on-board voltage of 12V.

It is a complex engineering device, which includes unique and modern technological software and hardware solutions. While developing we were using the most up-to-date electronics from world's best manufacturers. The device is built using high-precision mounting and control machinery; thus, we guarantee highest possible quality, reliability and stable technical characteristics for the whole operation period.

The system is built for your convenience: it's ergonomic, reliable, has the highest security and service characteristics, 3 years unconditional warranty and free service and support. We are happy to provide any support we can – feel free to use our online support.

! WARNING! IT IS STRONGLY RECOMMENDED TO HAVE A PROFESSIONAL CAR MECHANIC TO INSTALL THE SYSTEM. ANY CAR ELECTRONICS INSTALLER SHOULD BE ABLE TO INSTALL THE SYSTEM USING INSTALLATION SCHEME IN THIS MANUAL AND THE **ALARM STUDIO** OR **PANDORA SPECIALIST** SOFTWARE. MOST FEATURES ARE HIGHLY DEPENDENT ON COMPETENT INSTALLATION. OUR SYSTEMS ARE THOROUGHLY TESTED FOR QUALITY, SO IF A FEATURE FAILS TO PRODUCE EXPECTED RESULT, MOST LIKELY THE PROBLEM IS IN IMPROPER INSTALLATION.

This device has limited external factors resistance. It should not be subjected to water beyond occasional splatter.

The base unit is designed to operate at temperatures from -40°C to +85°, the degree of protection is IP54.

The control units (remotes, tags, etc.) are designed to operate at temperatures from -10°C to +40°C, the degree of protection is IP40.

See wiring diagram to find information about additional devices and options.

Our web-site: pandorainfo.com
Customer support: support@pandorainfo.com



Product is in conformity with Electromagnetic Compatibility
Directive EMC 2004/108/EC and R&TTE Directive 1999/5/EC

Table of contents

General information	4
System set	4
Read before using	5
PIN-codes of the system	6
System modules layout	6
Owner's personal card	7
External VALET button	7
Base unit	8
Information signals of the system	9
System functions and modes	11
Security mode	11
Security zones	12
Owner authorization devices and functions	12
Checking the number of paired devices	14
Immobiliser radio tag	15
Functions of the button	15
Indication of the SEND LED	16
Installation/replacing a battery of the tag	16
Prompt entry/change of the main owner phone number	17
Updating firmware of the tag	17
Wrist bracelet PANDORA BAND	18
Switching on/off the Band	18
Charging the Band	18
Button's functions	19
Firmware update	19
Information icons	20
Control the system by a phone	21
Changing settings via a phone	23

System installation	25
General installation requirements	25
Base unit connectors description	26
Wiring diagram	28
Online service and mobile application	30
Registration	31
Login	31
Adding a system to your account	31
Writing a mobile device to the system memory	32
Control the system	34
Arming	34
Disarming	35
PANIC mode	36
Vehicle search function	37
Season storage mode	37
Service mode	37
Control over the system in case of emergency	39
Emergency disarming	41
Emergency control of the anti-theft functions	41
Programming the system	43
Pandora Specialist Application	44
Pandora Alarm Studio	44
Updating firmware	45
Programming table	46
Additional devices	51
Warranty obligations	52
Installation certificate	55
Acceptance certificate	56
Warranty Card	56

GENERAL INFORMATION

System set Pandora Smart Moto and Pandora Smart Moto Plus

1. User and installation manual	1
2. Owner's personal card	1
3. Immobiliser tag BT-780	1
4. External VALET button	1
5. Base unit with the main cable	1
6. Blocking relay	1
7. Magnetic reed sensor	2
8. Packaging	1
9. External temperature sensor	1

Pandora Smart Moto

10. Piezo siren PS-330	1
------------------------	---

Pandora Smart Moto Plus

10. Wrist bracelet Pandora Band	1
11. Piezo siren PS-332BT	1
12. Door sensor DMS-100BT	1

! NOTE! THE MANUFACTURER RESERVES THE RIGHT TO CHANGE THE SYSTEM SET AND CONSTRUCTION OF THE PRODUCT TO IMPROVE IT'S TECHNOLOGICAL AND OPERATIONAL PARAMETERS WITHOUT NOTIFICATION.

Read before using

Carefully read this manual before starting installation and using the security-service system. Pay attention to the text marked with 

 THE SECURITY-SERVICE SYSTEM IS A COMPLEX TECHNICAL PRODUCT. SYSTEM INSTALLATION AND CONFIGURATION MUST BE CARRIED OUT ONLY BY A SKILLED PROFESSIONAL.

 FEATURES AND SYSTEM MODES, CONTROL OF THE VEHICLE'S ZONES DEPEND ON THE TYPE OF CONNECTION AND SYSTEM SETTINGS, ORIGINAL VEHICLE OPERATION LOGIC AND TRIM.

 THE SYSTEM SET INCLUDES THE «OWNER'S PERSONAL CARD». THIS CARD CONTAINS INFORMATION UNDER THE PROTECTIVE LAYER THAT IS INTENDED ONLY FOR THE OWNER OF THE SYSTEM. MAKE SURE THAT THE PROTECTIVE LAYER ON THE OWNER'S PERSONAL CARD IS INTACT AFTER THE INSTALLATION OF THE SYSTEM. READ THE «OWNER'S PERSONAL CARD» SECTION OF THIS MANUAL BEFORE ERASING THE PROTECTIVE LAYER.

 WHEN SYSTEM INSTALLATION IS FINISHED:

- CHECK THE SYSTEM OPERATION AND FUNCTIONS WITH A SPECIALIST.
- WE RECOMMEND THAT YOU MARK EACH WORKING FUNCTION WITH A SIGN  IN THE «CONTROL THE SYSTEM» SECTION.
- CHECK THAT THE «INSTALLATION CERTIFICATE» AND «WARRANTY CARD» ARE FILLED OUT. THESE DOCUMENTS MAY BE REQUIRED FOR CONTACTING THE CUSTOMER SUPPORT.
- ASK AN INSTALLER TO MARK THE LAYOUT OF THE SYSTEM COMPONENTS ON THE DIAGRAM. THIS INFORMATION MAY BE REQUIRED FOR DIAGNOSTIC/CONFIGURING OR EMERGENCY DEACTIVATION OF THE SYSTEM.
- WE RECOMMEND THAT YOU CHANGE THE DEFAULT VALUE OF THE PIN-CODES.

PIN-codes of the system

The «Secret PIN-code»

(is written on the «Owner's personal card»)

The «Service PIN-code»

(default value is 1-1-1-1)

The «Guest PIN-code»

(default value is 1-2-3-4)



The «Immobiliser PIN-code»

(is used for the Code Immobiliser (pin-to-drive) function)

CANNOT BE CHANGED						
<input type="text"/>	-	<input type="text"/>	-	<input type="text"/>	-	<input type="text"/>
<input type="text"/>	-	<input type="text"/>	-	<input type="text"/>	-	<input type="text"/>
<input type="text"/>	-	<input type="text"/>	-	<input type="text"/>	-	<input type="text"/>

! IT IS RECOMMENDED THAT YOU WILL WRITE DOWN THE CHANGED OR CREATED VALUES OF ALL PIN-CODES. ELIMINATE THIRD-PARTY ACCESS TO THIS INFORMATION.

System modules layout

- 1 External VALET button 
- 2 Base unit 
- 3 Siren 
- 4 Circuit being blocked
- 5
- 6
- 7

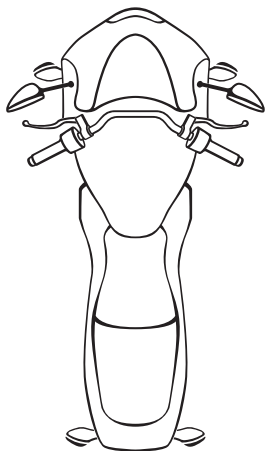

Owner's personal card

! ERASE THE PROTECTIVE LAYER CAREFULLY. DO NOT USE ANY SHARP OBJECTS TO AVOID DAMAGING OF A HIDDEN INFORMATION UNDER THE PROTECTIVE LAYER. THE INFORMATION ON THE OWNER'S PERSONAL CARD COULD NOT BE CHANGED OR RESTORED IN CASE OF DAMAGE OR LOSE. ELIMINATE THIRD-PARTY ACCESS TO THIS INFORMATION.

The owner's personal card contains private information under a protective layer:

- **PIN** (the «Secret PIN-code») is a 4-digit number. This code can be used to disarm the system to deactivate Immobiliser functions and to activate service mode. It can be also used to enter programming mode.
- **LOGIN** is a 10-digit number. This information is used to add the system to the online service and mobile applications.
- **PASS** contains 8 characters and can consist of digits, lower and upper case letters). This information is used to add the system to the online service and mobile applications.
- **Phone number** is a phone number of the preinstalled SIM card.

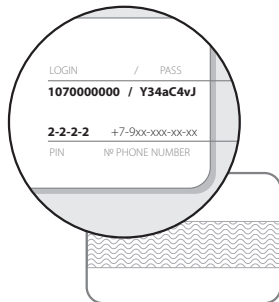

External VALET button

An external VALET button with a three-color status LED indicator is placed inside a vehicle (see the System modules layout).

The button is used for programming the system, arming/disarming, activating/deactivating Immobiliser mode.



Base unit

Built-in LTE module (4G LTE/3G/2G | GPS/GLONASS) – provides a connection with our online-service pandora-on.com and mobile applications), allows to control the system by a phone using DTMF-commands, voice and SMS notifications, LBS-coordinates (only by DTMF-command), automatic date and time detection, precise GPS location (with Tracking function).

Built-in nano-SIM port is used to work with the built-in GSM modem. The phone number of the SIM-card installed in the base unit is written on the Owner's personal card.

! THE SIM-CARD CAN BE CHANGED. THE SIM-CARD SHOULD BE REPLACED AND THE FOLLOWING SETTINGS SHOULD BE PERFORMED ONLY BY A QUALIFIED SPECIALIST.

2.4GHz radio channel, Bluetooth 5.0 protocol (BT5.0) - supports additional Bluetooth devices (see the «Additional devices» section), including a mobile phone.





















Built-in 3D accelerometer is used to detect shock/motion/tilt including 2 separate zones of shock sensor (alarm and warning), the system allows to adjust sensitivity of each zone, to use data from the accelerometer to block the engine on movement.

Temperature sensors allow the system to measure temperature of different zones: outside temperature – built-in sensor of the main unit, engine temperature – external temperature sensor. System allows to change default sensor's settings, use the information from the temperature sensor of the DMS-100 BT, program automatic engine start and stop.

Built-in battery allows to notify the owner in case of main power disconnection while system is armed. The battery will be charged automatically when engine is running.

Built-in micro-USB port – update and configuration of the system using the Pandora Specialist mobile app or Alarm Studio program.

Information signals of the system

SOUND  / LIGHT  SIGNALIZATION	
SIGNALS (sound / light)	DESCRIPTION
1x  / 1x 	Arming
2x  / 2x 	Disarming
1x 	Activating Service mode* Correct input of the «Immobiliser PIN-code»*
2x 	Deactivating Service mode*
3x  (3 times)	A battery in a radio tag is discharged (when turning on the ignition)*
4x  (4 times)	Absence of the authorization device (when turning on the ignition)*
5x  / 5x 	Vehicle search
25 sec  / 25 sec 	Engine blocking warning in Anti-Hi-Jack mode
30 sec  / 30 sec 	Alarm - alarm level of a sensor is triggered, PANIC mode
3x  / 1x 	Warning level of a sensor is triggered
4x  / 4x 	«Sensors were triggered» signal when disarming / «Sensors are triggered» signal when arming



* ADDITIONAL SETTING MUST BE MADE FOR THE SOUND NOTIFICATION (AN ADDITIONAL LOGIC «BEEPER» MUST BE ASSIGNED TO THE OUTPUT OF THE «SIREN» CHANNEL) - THE CONFIGURATION SHOULD BE MADE BY A QUALIFIED TECHNICIAN.





EXTERNAL BUTTON LED INDICATOR SIGNALS

SIGNALS	DESCRIPTION
THE SYSTEM IS ARMED	
Short red flashes	System is armed
Short green flashes	System is armed (authorization devices are in the coverage zone)
Fast red flashes	Alarm
THE SYSTEM IS DISARMED	
Faded	System is disarmed
Red	System is preparing for the automatic or delayed arming
Green (when turning on the ignition)	System is in Service mode
Orange flashes (when turning on the ignition)	Confirms the number of paired remotes, watches, bands
Green flashes (when turning on the ignition)	Confirms the number of paired radio tags
Red flash (when turning on the ignition)	Confirms a paired mobile device
WHEN ENTERING THE «SECRET PIN-CODE» OR THE «SERVICE PIN-CODE»	
Orange flash	Confirms a VALET button pressed
Short red flash	Confirms a digit input PIN-code is incorrect
Red and green flashes	Confirms correct PIN-code



SYSTEM FUNCTIONS AND MODES

Security mode





The system confirms arming with **1x**  **sound** and **1x**  **light** signals. When the system is armed, the system monitors security zones with separated warning and alarm level of triggering:

- Warning mode - this mode activates when there is a slight impact on the shock sensor or additional sensor. It is accompanied with **1x**  **light** and **3x**  **sound** signals;
- Alarm mode - this mode activates when a sensor or one of the security zones is triggered. It is **30 sec.**  **light** and **30 sec.**  **sound** signals. The alarm signals can be cancelled by an arming or disarming command.

If one of the security zones is triggered the system:

- records this event in its non-volatile memory;
- activates the alarm or warning mode;
- informs an owner by all available means;
- blocks the engine (in accordance with the settings and connections).
- If one of the security zones is opened at the moment of arming, the system will produce **4x**  **sound** and **4x**  **light** warning signals.

If one of the security zones fails, the system will forcibly turn off this zone. If a switch triggers more than 9 times in a row, it will be disabled until the next arming. The shock/tilt/motion sensor is temporarily deactivated (15 sec.) if it has been triggered more than 3 times in a row.

The system confirms disarming with **2x**  **sound** and **2x**  **light** signals. The system deactivates engine blocking (if the Immobiliser function and additional blocking are not used). If there were alarm events (except warning level) during the armed period, the system will produce **4x**  **sound** and **4x**  **light** warning signals. The system continues to display all zones when it is disarmed, but the information is not saved in the memory.

 FOR EMERGENCY DISARMING SEE «CONTROL THE SYSTEM IN CASE OF EMERGENCY». ENGINE BLOCKING WHILE DRIVING POSES AN INCREASED RISK. WE STRONGLY RECOMMEND THAT YOU BE PARTICULARLY CAREFUL WHEN USING THIS METHOD OF BLOCKING.

Security zones

- Outside temperature (status)
- Engine temperature (status)
- Voltage of the on-board circuits (status)
- Additional sensor (security zone - alarm and warning level)*
- Shock sensor (security zone – alarm and warning level)
- Tilt sensor (security zone – alarm level)
- Motion sensor (security zone – alarm level)
- Turning ignition on (status, security zone – alarm level)
- Pressing brake (status, security zone – alarm level)
- Pressing clutch (status, security zone – alarm level)
- Opening a trunk (status, security zone – alarm level)

! CONTROL OF THE STATUSES AND SECURITY ZONES DEPENDS OF THE SYSTEM SETTINGS AND CONNECTIONS.

* OPTION.

Owner authorization devices and functions

Authorization devices

Authorization devices are Bluetooth devices paired with the system (radio tags, remote controls, mobile phone with the app, band). The devices are used to recognize an owner in the radio coverage zone of the base unit, to arm/disarm the system (Hands Free mode) and to implement Immobiliser or Anti-Hi-Jack functions.

Arming/Disarming by clutch lever

You can arm/disarm the system by a clutch lever if an authorization device is in the coverage zone.

! THIS MODE IS ENABLED BY DEFAULT. IT IS REQUIRED TO MAKE ADDITIONAL CONNECTIONS FOR THIS MODE

Hands Free arming/disarming

This mode is used for automatic arming/disarming  when an owner with an authorization device is distancing  or approaching  a vehicle.

! THIS MODE IS DISABLED BY DEFAULT. THE CONFIGURATION SHOULD BE MADE BY A QUALIFIED TECHNICIAN.

Immobiliser mode

This mode is used to recognize an owner using authorization devices when the system is disarmed.

When turning on the ignition, the base unit performs a search for authorization devices in the radio coverage zone. If there is no any authorization device in the radio coverage zone, the system will block the engine. Engine blocking will occur immediately or at the time a motion sensor detects movement, it depends on the system settings. When an authorization device appears in the coverage zone, the system will exit blocking mode and will continue to work in normal mode.

I THIS MODE IS DISABLED BY DEFAULT. THE CONFIGURATION SHOULD BE MADE BY A QUALIFIED TECHNICIAN.

FOR EMERGENCY DISARMING SEE «CONTROL THE SYSTEM IN CASE OF EMERGENCY». ENGINE BLOCKING WHILE DRIVING POSES AN INCREASED RISK. WE STRONGLY RECOMMEND THAT YOU BE PARTICULARLY CAREFUL WHEN USING THIS METHOD OF BLOCKING.

Anti-Hi-Jack mode

The Anti-Hi-Jack mode helps to prevent aggressive seizure of a vehicle in case of disappearance of the authorization devices from the radio coverage zone when system is disarmed and ignition is on. If the system cannot detect an authorization device, the base unit will perform a delayed engine blocking. The siren will play the 'Engine blocking warning' ringtone before blocking. The engine will be blocked immediately or at the time the vehicle starts moving, it depends on the system settings. When an authorization device appears in the coverage zone, the system will exit blocking mode and will continue to work in normal mode.

I THIS MODE IS DISABLED BY DEFAULT. THE CONFIGURATION SHOULD BE MADE BY A QUALIFIED TECHNICIAN.

FOR EMERGENCY DISARMING SEE «CONTROL THE SYSTEM IN CASE OF EMERGENCY». ENGINE BLOCKING WHILE DRIVING POSES AN INCREASED RISK. WE STRONGLY RECOMMEND THAT YOU BE PARTICULARLY CAREFUL WHEN USING THIS METHOD OF BLOCKING.

Code Immobiliser (pin-to-drive) function

This function allows to use the pre-programmed «Immobiliser PIN-code» to disable the engine blocking, service mode, disarming the security system. The code must be entered using original vehicle controls (buttons/lever/pedal) and/or additionally installed elements.

AN EXAMPLE OF USING THE FUNCTION

- Turn on the ignition to disable engine blocking or service mode, turning on the ignition is not required if you want to disarm the system or control time channels.
- Enter the «Immobiliser PIN-code», code can consist max of 4 digits from 1 to 9.
 - Press the pre-programmed button/lever/pedal the number of times equals to the first digit.
 - Pauses between presses should not exceed 1 second. More than 1 second pause will be interpreted as the start of the next digit input.
- After entering the code correctly, the system will perform the programmed function.

I THIS MODE IS DISABLED BY DEFAULT. THE CONFIGURATION SHOULD BE MADE BY A QUALIFIED TECHNICIAN.

Checking the number of paired devices

The number of paired radio tags/mobile devices can be checked by the number of flashes of the LED indicator. The number of remotes/tags/mobile device can be checked when switching on the ignition (system must be disarmed). The number of orange flashes will indicate the number of paired remotes/bands/watches, the number of green flashes will indicate the number of paired radio tags, a following red flash will indicate a paired mobile device.

You can also check the number of paired radio tags/mobile devices by taking off and putting back on battery terminal. The system will emit short sound signals from a siren .



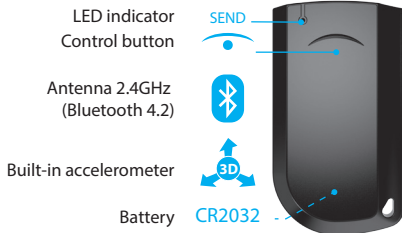

IMMOBILISER RADIO TAG

A radio tag is a device used to control a vehicle/system on a distance of a Bluetooth connection. The tag is also used as an authorization device for «Immobiliser/Anti-Hi-Jack/Hands Free» modes. The radio tag has: a control button  for arming/disarming and activating/deactivating Service mode; a built-in accelerometer, which allows the tag to go in the energy saving mode when there is no movement; LED indicator **SEND**.

! FOR CORRECT OPERATION, IT IS NOT RECOMMENDED TO PLACE THE RADIO TAG NEAR THE METAL OBJECTS, MAGNETIC AND ELECTRONIC DEVICES (CREDIT CARDS, PHONES, KEYS, REMOTES, ETC.). DO NOT EXPOSE THE RADIO TAG WITH HIGH TEMPERATURES, MOISTURE, OR STRONG IMPACTS. IT IS RECOMMENDED TO PLACE THE RADIO TAG ON THE BELT IN AN INDIVIDUAL CASE OR IN THE FRONT POCKET OF CLOTHING.



Functions of the button

ACTION	FUNCTION
 - Short press when ignition is off	Arm/disarm
 - Press and hold for 2 sec (system is disarmed)	Change the «Main owner's phone number»
 - Press and hold for 3 sec (ignition on)	Activating/deactivating Service mode
 - Press and hold for 6 sec (programming mode)	Pair a tag with the base unit
 - Press and hold for 10 sec	Firmware update

Indication of the SEND LED

SIGNALS	DESCRIPTION
one flash	Arm/disarm Confirmation of arming Low battery level (when installing a battery)
two flashes	Confirmation of disarming
three flashes	High battery level (when installing a battery)
faded constant light	Battery is discharged (when installing a battery, when the button is pressed)

Installation/replacing a battery of the tag CR2032

To install or replace the battery (CR2032), carefully follow these steps:

1. Turn the battery cover in the «OPEN» direction;
2. Remove the battery cover;
3. Remove the battery from the battery compartment and, observing the polarity, install a new one (when installing a high-quality battery, the **SEND** indicator light will produce three red flashes);
4. Install and rotate the battery cover in the «CLOSE» direction. After completing the procedure, you can continue to operate the radio tag in normal mode.

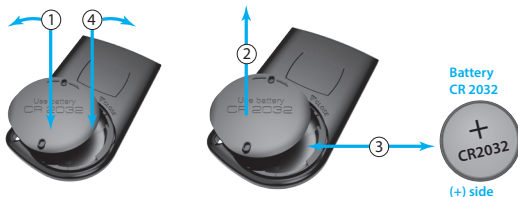

Prompt entry/change of the main owner phone number

For a prompt entry/change of the main owner phone number follow next steps:

- Disarm the system, being near the vehicle call the system phone number, wait for the answer (Enter the «Guest PIN-code if you are calling not from the owner phone number. Default value is 1-2-3-4);
- Press and hold button  on the radio tag until two flashes of the **SEND** indicator, then release button;
- System will save incoming phone number as the «Main owner phone number» and will repeat it;
- End call.

 THE PHONE NUMBER COULD BE ALSO CHANGE USING MOBILE DEVICE (SEE «CHANGING SETTINGS VIA PHONE» SECTION).

Updating firmware of the tag

- Download the Pandora BT application (Android / iOS) or Pandora Specialist (Android) on the devices equipped with a Bluetooth 4.0 Low Energy or higher module.
- Open the mobile app, find the system.
- Press and hold the button  of the radio tag until the 10th flash of the «**SEND**» indicator, then release the button.
- Select the found device and select one of the update option: FILE MANAGER – firmware will be uploaded from the phone storage (only for Android). INTERNET – firmware will be uploaded by an internet connection.

PANDORA BAND

I PANDORA BAND IS INCLUDED IN THE PANDORA SMART MOTO PLUS SET.

Wrist-wearable band designed to conveniently control vehicle equipped with Pandora Bluetooth system

- Display: OLED, 128x32 mm
- Interface: Bluetooth 5.0
- Sensors: accelerometer
- Accu: Li-Po, 85 mAh
- Charging input: micro-USB
- Control button **■**

I PANDORA BAND IS A UNIFIED CONTROL DEVICE - ITS OPERATION DEPENDS OF THE SECURITY SYSTEM FUNCTIONAL. IT IS NECESSARY TO ENABLE «USE D-030 AS A RADIO TAG» OPTION TO USE BAND AS AN OWNER'S AUTHORIZATION DEVICE.



Switching on/off the Band

Press and hold the button **■** for 3 sec to switch ON, 8 sec to switch OFF. Charge the battery if it will not switch on.

Charging the Band

There is a battery charge indicator on the display. Charge the battery if the device does not turn on or the charge indicator shows low level (10%).

- remove capsule from the band;
- connect the micro-USB connector of the cable to the capsule;
- connect the USB connector of the cable to the charger;
- charge the battery until the indicator is full (100%);
- disconnect the cable and insert the capsule into the band - device is ready for use.

I CHARGER AND USB CABLE ARE NOT INCLUDED IN THE SET.

Button's functions

BUTTON'S FUNCTIONS	FUNCTION
■ - briefly (ignition off)	Arming/disarming the security system
■ - 2 sec. (system disarmed)	Change the «Main owner phone number»
■ - 3 sec. (ignition on)	Activate/deactivate Service mode
■ - 3 sec. (band is switched off)	Switch on the Band
■ - 6 sec. (programming)	Pair the Band with a base unit
■ - 8 sec. (band is switched on)	Switch off the Band
■ - 10 sec.	Firmware update

* PANDORA BAND AUTOMATICALLY SYNCHRONIZES THE TIME WITH THE SYSTEM BASE UNIT AND DISPLAYS COUNTED STEPS (THE COUNTER IS RESET BY TIME - 0:00 AM).

Firmware update

Install Pandora BT (Android/iOS) or Pandora Specialist Apps on a smartphone or a tablet, equipped with Bluetooth 4.0 or higher.

- open mobile app, search for a device;
- press and hold control button for 10 sec or connect micro-USB cable while holding control button;
- choose the BAND in the mobile App and start the update: «INTERNET» - software will be downloaded from a server; «FILE MANAGER» - select previously downloaded software (Android only).

Information icons

 Connection state

 Security system status

 Charge indicator

 Current time

 Process scale

 Counter

 Low voltage

 Shock sensor
(alarm level)

 Shock sensor
(warning level)

 Tilt sensor
(alarm level)

 Motion sensor
(alarm level)

 Ignition
(alarm)

 Brake
(alarm)

 Clutch
(alarm)

 Trunk
(alarm)

 Additional sensor
(alarm level)

 Additional sensor
(warning level)

CONTROL THE SYSTEM BY A PHONE

! FOR THE CORRECT OPERATION OF THE GSM FUNCTIONS, AN OWNER SHOULD MONITOR THE STATUS/BALANCE OF THE SIM CARD INSTALLED IN THE SYSTEM. IF THE SIM CARD IS BLOCKED OR DEFECTIVE, GSM FUNCTIONS OF THE SYSTEM WILL BE UNAVAILABLE.

Call the system's phone number, wait for the answer. Enter a command code.

#	Return to previous menu/state	4 5 6 *	Switch on additional channel
*	Repeat the last message	6 5 4 *	Switch off additional channel
1 *	Arming	2 5 8 *	System information
0 *	Disarming	2 2 2 *	Disable HandsFree
1 0 *	Silent arming	2 2 3 *	Enable HandsFree arming
0 0 *	Silent disarming	2 2 4 *	Enable HandsFree disarming
9 *	Help	2 9 7 *	End call
1 5 *	Tow truck mode	5 5 1 *	Activate Service mode*
1 0 0 *	Request GSM balance	5 5 2 *	Deactivate Service mode
3 3 3 *	Additional function F via CAN	6 6 6 *	Activate engine blocking
5 0 0 *	Request GPS coordinates	9 9 9 *	Deactivate engine blocking*
7 5 3 *	Connect to server	9 9 8 *	Deactivate authorization devices*
		8 8 8 *	Activate authorization devices

! *IT IS REQUIRED TO ENTER THE «SECRET PIN-CODE» AFTER DIALING A COMMAND.

Voice help

The system has a voice help menu. During a voice call to the system, dial 9* and listen to the information about system control commands.

To end the session, hang up the phone.

Repeat the last message

To repeat any message, press * during a voice call to the system.

Request current coordinates

1. Call the system number. Wait for the answer.

2. Dial 500*.
3. The system will confirm: «Current coordinates are sent via text message» and will send text message with coordinates and a web link to a map to your phone.
To end the session, hang up the phone.

Request GSM balance

1. Call the system number. Wait for the answer.
2. Dial 100*.
3. The system will confirm: «Balance information is sent via text message» and will send text message with account balance information to your phone.
To end the session, hang up the phone.

Tow truck mode

This mode is intended for car transportation with preservation of arming function. Tow truck mode can be activated only when the system is armed, it will be deactivated automatically when disarming.

1. Call the system number. If the system is in PANIC mode, receive an emergency call. Wait for the answer.
2. Dial 15* to enable the «Tow truck» mode, the system will disable motion, shock and tilt sensors.
To end the session, hang up the phone.
3. To disable this mode, disarm the system.

Activating/Deactivating engine blocking

You can block a vehicle engine using any phone. The engine will remain blocked until phone command «Unlock engine» will be sent and the «Secret PIN-code» will be entered. This blocking cannot be disabled by any other means.

1. Call the system number and wait for the answer.
2. Dial 666* to block an engine or 999* to unlock it (after dialing 999* you should enter the «Secret PIN code» that is located on the owner's personal card).

! ALL OTHER COMMANDS CAN BE ENTERED IN THE SAME MANNER.

Changing settings via a phone

1 *	1 *	Owner number -> #
2 *	2 *	Additional owner number -> #
3 *	3 *	Second additional owner number -> #
4 *	4 *	Account balance inquiry number -> #
5 *	5 *	System's number -> «#»

2 *	1 *	Voice calls on alarm
2 *	2 *	Voice calls on triggering warning level of the sensors
5 *	5 *	Voice calls on restoring GSM connection
6 *	6 *	Voice calls on disarming
7 *	7 *	Voice calls on entering programming mode
8 *	8 *	Voice calls when radio relay connection is lost
9 *	9 *	Voice calls when on-board voltage is low
0 *	0 *	Voice calls on accident

3 *	1 *	Text messages on alarm
2 *	2 *	Text messages on triggering warning level of the sensors
5 *	5 *	Text messages on restoring GSM connection
6 *	6 *	Text messages on disarming
7 *	7 *	Text messages on entering programming mode
8 *	8 *	Text messages when radio relay connection is lost
9 *	9 *	Text messages when on-board voltage is low
0 *	0 *	Text messages on accident

5 *	1 *	Changing guest PIN-code
2 *	2 *	Entering as guest
5 *	5 *	Set threshold voltage for sending text message

7 *	1 *	Settings of the warning level of the shock sensor sensitivity
2 *	2 *	Settings of the alarm level of the shock sensor sensitivity
3 *	3 *	Settings of the motion sensor sensitivity
4 *	4 *	Settings of the tilt sensor sensitivity
5 *	5 *	Settings of the warning level of the supplementary sensor sensitivity
6 *	6 *	Settings of the alarm level of the supplementary sensor sensitivity

8 *	1 *	GSM connection
2 *	2 *	Money saving mode of the GSM connection
3 *	3 *	Voice calls in roaming service

9 *	1 *	Set up date
2 *	2 *	Set up time

Disarm the system, call the system number, wait for the answer, switch on the ignition for 1-3 seconds (but no more than 5 seconds), then switch it off. The system will enter the settings mode.

An example of changing the owner main number:

1. Enter the setting menu via a phone according to the instruction above;
2. Dial DTMF command 1*(phone number settings) and 1*(owner main number);
3. Enter new owner number in the format *XXXXXXXXXX # (the system recognizes «*» as «+»);
4. To confirm, dial 1*.

! THERE ARE 2 WAYS TO CHANGE MAIN OWNER PHONE NUMBER

1. VIA A PHONE, USING DTMF COMMANDS SETTINGS MODE.

2. USING RADIO TAGS: TURN ON THE IGNITION WHEN THE SYSTEM IS DISARMED AND CALL THE SYSTEM PHONE NUMBER. WAIT FOR THE ANSWER, DIAL THE «GUEST PIN-CODE» (DEFAULT VALUE IS 1-2-3-4) IF YOU ARE CALLING NOT FROM THE MAIN OWNER NUMBER, THEN PRESS AND HOLD THE BUTTON ON THE RADIO TAG FOR 2 SECONDS (UNTIL THE SECOND FLASH OF THE SEND INDICATOR). RELEASE THE BUTTON, THE SYSTEM WILL RECOGNIZE THE INCOMING PHONE NUMBER AS THE «MAIN OWNER PHONE NUMBER».

SYSTEM INSTALLATION

General installation requirements

- Install the base unit in secured places with difficult access.
- Install securely each system's component, as conditions of the vehicles standard operation can harm functionality of the alarm system and cause damage to the vehicle original systems, including the elements of safety in motion.
- The system installation should be performed when the system sockets and the negative battery terminal are disconnected.
- The base unit power supply should be switched off when connecting to CAN-bus. The system installation can be performed via twisting together or via lead tin soldering followed by isolation of a switching place.
- When wiring, pay attention to sections and materials of switched conductors, if they are different, bring electrochemical potentials to the minimal difference. The isolation should not allow for moisture to reach wiring, as the presence of moisture will increase electrochemical destruction of wires (this is especially important for the large current circuits).
- Switched connections should be placed as high as it is possible in the cavities so water condensate will not form drops on the switching location.
- To avoid the destruction of compounds by vehicle vibration, ensure that there is a bit of free length to the wiring, providing enough sagging.
- Do not allow wiring in places where the wires isolation can be destroyed by abrasion.
- Electronic system units should be placed sockets down and as high as possible to avoid condensate reaching electronic components through the socket.
- When installing base unit, secure it to the vehicle body/frame for correct operation of in-built shock sensor.
- All unused system wires during the installation must be insulated and secured to prevent accidental touching of a vehicle body or other wires.

Micro-USB connector

This connector is used to configure and update the system with Pandora Alarm Studio or Pandora Specialist App.

Main cable

The main cable contains low-current programmable channels: inputs «INP» and outputs «CH» with a preset logic. Changing the preset logic is available in the system settings «Inputs and outputs» or «Time channels» menus. Additionally, in the «Input settings» submenu the «INP» channels can be reassigned from the normally open type «NO» (the system reacts to the appearance of the potential corresponding to the scheme) to the normally closed type «NC» (the system reacts to the disappearance of the potential corresponding to the scheme).

- **Wire №1 | Red | POWER SUPPLY (+12V) 10A** — System power supply. It should be securely connected to the reliable conductor with a constant voltage of +12V. The wire is equipped with a 10A fuse.
- **Wire №2 | Black | GROUND (-)** — ground. It should be connected to a vehicle grounding spot (-). This wire should be connected FIRST during the installation.
- **Wire №3 | White** — channel for connecting of the external temperature sensor, default logic is «Engine temperature sensor». It is connected to the red wire of the sensor, the black wire of the sensor is connected to the ground (-).
- **Wire №4 | White/red | LED/VALET** — channel for connecting the external VALET button. It is connected to the red wire of the external button.
- **Wire №5 | Yellow | (+) | INP1** — default setting is positive status «Ignition» input. It is connected to the ignition switch or other wire, where +12V appears when the ignition is turned on and does not disappear until the ignition is turned off. This input is mandatory for connection.
- **Wire №6 | Green | 200mA (-) | INP2/CH4** — default setting negative status «NC blocking» output. Channel for controlling the blocking relay with a normally closed contact group (the channel is enabled when: the system is armed and ignition being switched on, the system is disarmed but the Immobiliser or Anti-hi-Jack mode is enabled and the ignition being switched on).
- **Wire №7 | Grey | 200mA (-) | CH1/INP4** — default setting negative status «Clutch» input. Is used for system arming/disarming in the presence of authorization devices (see 1.2.4 setting «Arming/disarming by clutch lever»). It is connected to the wire what becomes grounded when the clutch lever is pressed.
- **Wire №8 | Orange/black | CAN-L** - digital bus «CAN-Low». It is connected to the corresponding CAN-Low wire of the vehicle. Before connecting the digital bus, you must select the vehicle model (model code). Information available on www.loader.pandorainfo.com and in the Pandora Specialist App and Pandora Alarm Studio.

- **Wire №9 | Orange | 6A (+12V) | CH7** — default logic is «Turn indicators». Connect this wire to (+) control wire of the left or right turn indicators. The wire is equipped with a 7.5A fuse.
- **Wire №10 | Orange | 6A (+12V) | CH6** — default logic is «Turn indicators». Connect this wire to (+) control wire of the left or right turn indicators. The wire is equipped with a 7.5A fuse.
- **Wire №11 | Purple | 2A (+12V) | CH5** — default logic is «Siren». Connect this wire to +12V wire of the siren. When using owner's authorization devices and Immobiliser or Anti-hi-Jack modes, it is recommended to set both «Siren» and «Beeper» logic in the settings.
- **Wire №12 | White/Green | LED/VALET** — channel for connecting the external VALET button. It is connected to the black wire of the external button.
- **Wire №13 | White/blue | (+) | INP3** — default logic is «Brake». Connect this wire to a wire where +12V appears when the brake pedal or lever is pressed.
- **Wire №14 | White/brown | 200mA (-) | CH2/INP5** — default logic is «Trunk». Connect this wire to a wire that becomes grounded when the pannier opens. It is necessary to change the input type from NO to NC in the «Inputs settings» if a magnetic reed sensor is used.
- **Wire №15 | Brown | 200mA (-) | CH3/INP6** — default logic is «Trunk». Connect this wire to a wire that becomes grounded when the pannier opens. It is necessary to change the input type from NO to NC in the «Inputs settings» if a magnetic reed sensor is used.
- **Wire №16 | Orange/black | CAN-H** — digital bus «CAN-High». It is connected to the corresponding CAN-High wire of the vehicle. Before connecting the digital bus, you must select the vehicle model (model code). Information available on www.loader.pandorainfo.com and in the Pandora Specialist App and Pandora Alarm Studio.

BASE UNIT PLACEMENT

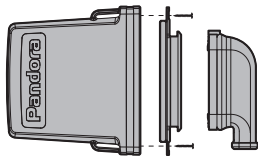
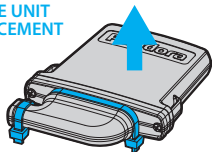

WARNING! Update firmware of the base unit before installation. If the CAN-bus connected, choose the vehicle model code.

WARNING! The installation locations of the base unit and system elements must meet their temperature, dust- and moisture-protection characteristics. The base unit and blocking relay are designed to operate at temperatures from -40°C to $+85^{\circ}\text{C}$, the degree of protection is IP54.

WARNING! The base unit must be placed vertically or horizontally, do not cover the front side of the unit (the side with the «Pandora» sign).

WARNING! Fixate the protective cap using clamps when the installation is finished. Isolate the protective cap and wires with the insulating tape.

WARNING! All power circuits of additional devices that are not powered through the base unit of the system should have their own fuses.

Antenna
4G LTE | GPS/GLONASS

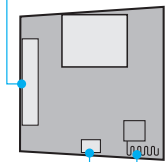

WARNING! Do not shield the built-in antennas when installing the system and additional devices. Keep minimum distance of 2 cm between the modules and metal parts.

micro-USB Antenna
2.4GHz (BT 5.0)

Battery

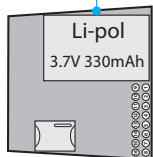

WARNING! Disconnect the power supply before installing/replacing a SIM-card.

nano-SIM

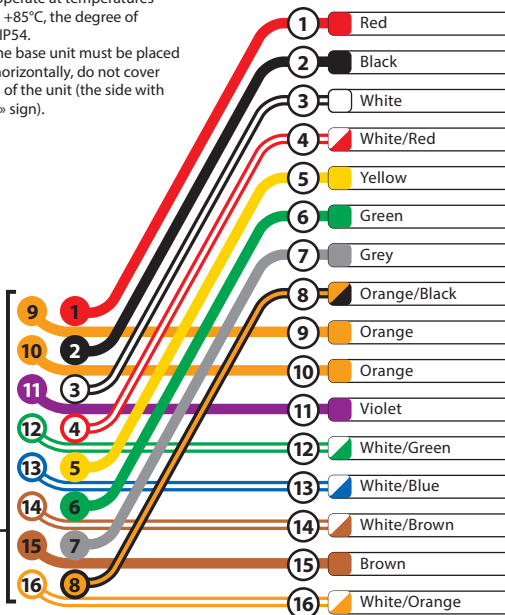

WIRING DIAGRAM Pandora SMART MOTO

WARNING! The system is a maintenance-free device. In case of failure you must immediately contact our local supplier.

WARNING! All wireless accessories from the kit are already paired with the base unit. The maximum number of paired Bluetooth accessories is 14.

IT IS FORBIDDEN to install the system on a vehicle with normal voltage other than 12V.

IT IS FORBIDDEN to install the system with damaged output cables.

IS FORBIDDEN to change or bypass original fuses of a system in the installation process.

IT IS FORBIDDEN to install the temperature sensor at the place where temperature is higher than the operating range of the sensor (+125°C) and cable (+80°C).

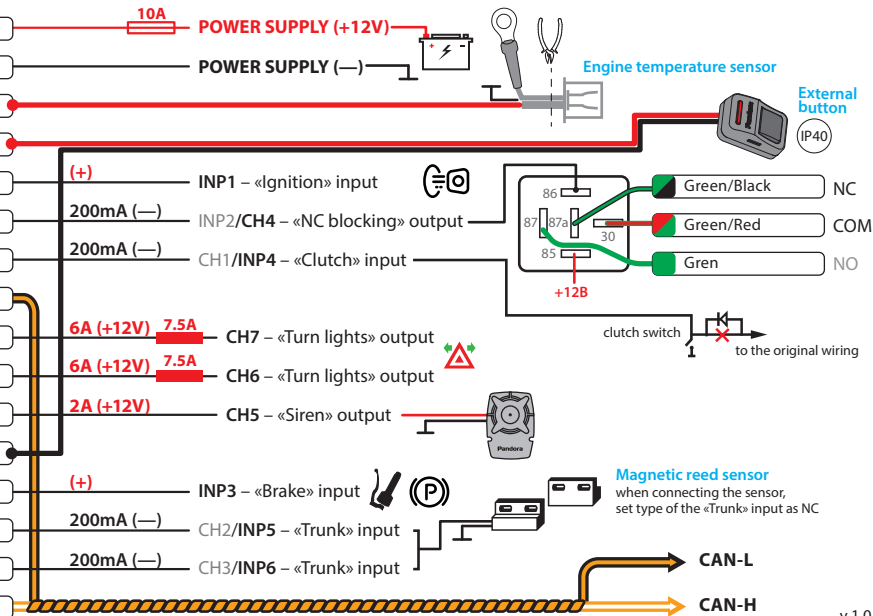

ONLINE SERVICE AND MOBILE APPLICATIONS

Telemetric functions of the system allow you to control your vehicle using the online service pandora-on.com or mobile app - Pandora Connect. A SIM card with Internet access is installed in the system to provide this functionality.

When approaching the vehicle or when Internet connection is missing a mobile phone with the app installed can work with the system via a Bluetooth connection. The mobile phone must be paired with the system.

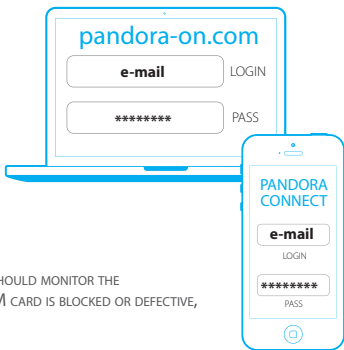

! FOR THE CORRECT OPERATION OF THE GSM FUNCTIONS, AN OWNER SHOULD MONITOR THE STATUS/BALANCE OF THE SIM CARD INSTALLED IN THE SYSTEM. IF THE SIM CARD IS BLOCKED OR DEFECTIVE, GSM FUNCTIONS OF THE SYSTEM WILL BE UNAVAILABLE.

Before using the online-service, it is required to create an account (Registration), login to your account (using your email and password created on the registration step) and add the system to your account (enter information from the «Owner's personal card»).

Web-service: <https://pandora-on.com>.

The Pandora Connect mobile app is available for downloading from the corresponding app store:

App Store for iOS devices;
Google Play for Android devices.

! THE MANUFACTURER RESERVES THE RIGHT TO MAKE CHANGES OF THE INTERFACE AND FUNCTIONALITY OF THE INTERNET SERVICE AND MOBILE APPLICATION WITHOUT NOTIFYING THE CONSUMER.



Registration

Visit the website or open the mobile app to create an account. You will create the data to sign in: LOGIN – your email, PASSWORD – a password entered during the registration. You will receive an email with a confirmation link. Click the link to complete the registration procedure.

Login

After completing of the registration process, you can login to the online service via a computer's web browser or via the mobile app Pandora Connect. Use your previously created data:

Login - your e-mail;

Password - previously created password.

Adding a system to your account

The created account can support up to 3 telemetry systems. Use the information from the «Owner's personal card» to add the system to your account.

Go to the «Add a device/Add a system» window and enter the LOGIN and PASS from the «Owner's personal card», create a name for your vehicle and click «Add». If you need to use several systems/devices on the same account: enter the application settings, click «Change», click «+», in the «Device Registration» window, enter the data of a new system/device located on the «Owner's personal card».

! ERASE THE PROTECTIVE LAYER CAREFULLY. DO NOT USE ANY SHARP OBJECTS TO AVOID DAMAGING OF HIDDEN INFORMATION UNDER THE PROTECTIVE LAYER.

After this, you will be able to control, change setting and get information about the vehicle state through the online-service.

Writing a mobile device to the system memory

When approaching the vehicle or when Internet connection is missing a mobile phone with the mobile application Pandora Connect installed can work with the system via a Bluetooth connection. This type of connection allows you to control the system, receive status information and use your mobile phone as an authorization device.

I THE SYSTEM SUPPORTS BLUETOOTH CONNECTION ONLY WITH ONE MOBILE DEVICE. THE SETTINGS FOR USING THE MOBILE DEVICE AS AN OWNER AUTHORIZATION DEVICE ARE MADE BY A QUALIFIED TECHNICIAN.

I. ENTER THE PROGRAMMING MODE

Use the VALET button to enter the «Service PIN-code» (default value is 1-1-1-1). See the detailed instruction of code entering in the «Control over the system in case of emergency» section.

II. ENTER THE «PAIRING A MOBILE PHONE» PROGRAMMING LEVEL

After entering programming mode, press and hold the VALET button for 5 seconds (until the fifth signal of the Siren). The system will enter the «Pairing a mobile phone» programming level. The LED indicator will light green, the system is ready for pairing

I THE PREVIOUSLY PAIRED DEVICE WILL BE ERASED FROM THE SYSTEM MEMORY AFTER ENTERING THE LEVEL

















































III. PAIR A MOBILE DEVICE

Enable the Bluetooth connection in the mobile device, enter the app settings, click «Bluetooth control», click «Not defined». In the search box, establish a connection with the detected system. The red and green flashes of the «LED» indicator light and a single siren sound will confirm the pairing.

I IF THERE IS NO AUTOMATIC PAIRING, ENABLE THE «PIN REQUEST FOR PHONE PAIRING» ITEM IN THE «RADIO TAG AND MOBILE DEVICE FUNCTIONS» SETTINGS AND MAKE THE PAIRING PROCEDURE AGAIN. A MOBILE DEVICE WILL REQUEST A PIN-CODE (FACTORY PRE-SET IS 0-0-1-1-1-1 WHERE 4 LAST DIGITS ARE THE «SERVICE PIN-CODE»). THIS SETTING SHOULD BE MADE BY A QUALIFIED TECHNICIAN.

IV. EXIT PROGRAMMING MODE

Turn on the ignition and then turn off to exit programming mode.

VEHICLE/SYSTEM ZONES	CONTROLLED ZONES	SECURITY ZONES	NOTIFICATIONS		
			voice	sms	push
External temperature					
Engine temperature					
On-board voltage					
Shock sensor (alarm)					
Shock sensor (warning)					
Tilt sensor (alarm)					
Motion sensor (alarm)					
Ignition (alarm)					
Brake (alarm)					
Clutch (alarm)					
Trunk (alarm)					
Additional sensor (alarm)					
Additional sensor (warning)					



CONTROL THE SYSTEM

Arming



To arm the system when the ignition is off, use one of the methods described below. The system will confirm the command with 1x  short sound signal and 1x  flash of light signalization .







 **Clutch lever** – Press the clutch lever when an owner authorization device (radio tag, phone, band, watch) is in the coverage zone .

 **Radio tag** – A radio tag must be in the Bluetooth coverage area. Shortly press the control button  on the tag.

 **Pandora Band (Smart Moto Plus kit)** – the device must be in the Bluetooth coverage area. Shortly press the control button  on the Band.

 **Mobile app Pandora Connect** – When the system is online (there is an Internet or Bluetooth connection), press and hold the button  on the control panel until the scale is fully loaded. The icon of the current system mode will be changed .

 **Online-service PANDORA-ON.COM** – When the system is online (there is an Internet connection) press the button  on the control panel. The icon of the current system mode will be changed .

 **Phone** – Call the system number. Wait for the answer. Dial the (1) (*) command. To arm the system without siren signals dial the (1) (0) (*). The system will confirm the completed command will a voice notification «Command executed, security mode is switched on».



 **HandsFree mode** – Move with an authorization device away from your vehicle .



 **VALET button** – Press and hold the VALET button for 3 seconds. The system will be armed in 30 seconds. The LED indicator is lighting red during the countdown.



Disarming





To disarm the system, use one of the methods described below. The system will confirm the command with 2 short sound signals  and 2 flashes of turn indicators .











 **Clutch lever** – Press the clutch lever when an owner authorization device (radio tag, phone, band, watch) is in the coverage zone  .

 **Radio tag** – A radio tag must be in the Bluetooth coverage area. Shortly press the control button  on the tag.

 **Pandora Band (Smart Moto Plus kit)** – the device must be in the Bluetooth coverage area. Shortly press the control button  on the Band.

 **Mobile app Pandora Connect** – When the system is online (there is an Internet or Bluetooth connection), press and hold the button  on the control panel until the scale is fully loaded. The icon of the current system mode will be changed   .



 **Online-service PANDORA-ON.COM** – When the system is online (there is an Internet connection) press the button  on the control panel. The icon of the current system mode will be changed   .



 **Phone** – Call the system number. Wait for the answer. Dial the  command. To arm the system without siren signals dial the . The system will confirm the completed command will a voice notification «Command executed, security mode is switched off».

 **HandsFree mode** – Move toward the vehicle with an authorization device .

 **VALET button** – Enter the «Secret PIN-code» (see the «Emergency disarming using the VALET button» section).

PANIC mode



If your vehicle or you are in danger and you want to draw attention to your vehicle, you can use PANIC mode. In this mode the siren  will sound and turn signals  will flash repeatedly for 30 seconds. To activate this mode, use one of the methods described below.

 **Mobile app Pandora Connect** – When the system is online (there is an Internet or Bluetooth connection), press and hold the button  on the control panel until the scale is fully loaded. To switch this function off press and hold the button  on the control panel until the scale is fully loaded.

 TO CHANGE THE LOCATION OF THE BUTTONS ON THE CONTROL PANEL GO TO THE APP SETTINGS AND ENTER THE «CONTROL BUTTONS» MENU.

Vehicle search function

There is a special mode to easily find your vehicle on a massive parking while the system is armed. In this mode the system will sound the siren  and flash turn signals .

 **Phone** – Call the system number. Wait for the answer. Dial the  command. To flash turn signals without siren signals dial the . The system will confirm the completed command will a voice notification «Command executed».

Season storage mode

A special mode designed for long-term parking or seasonal storage of the vehicles. This mode significantly reduces the power consumption of the system by disabling the notification and control interfaces.

- Season storage mode is activated via the mobile app or automatically, regardless of the security mode. When the system is armed and Season storage enabled, the security zones are monitored. In case of violation of the security zone (s), Season storage mode will be temporarily disabled (for 15 minutes) for the owner notification.
- Season storage mode is disabled depending on the security mode:
 - if the system is armed, it is necessary to violate some security zone and disarm the system by any available way within 15 minutes;
 - if the system is disarmed, the ignition must be switched on.

 **Mobile app Pandora Connect** – When the system is online (only Bluetooth connection), press and hold the button on the control panel until the scale is fully loaded.



 TO CHANGE THE LOCATION OF THE BUTTONS ON THE CONTROL PANEL GO TO THE APP SETTINGS AND ENTER THE «CONTROL BUTTONS» MENU.



 **Automatic mode** – the system allows automatically activate the Season storage mode after a specified number of days after the last event (arming/disarming, changing the status of the security zone). 15 minutes before the activation of the mode, the system will send an SMS notification to the main owner phone number. If you call the system during this time (15 minutes), the activation of the mode will be postponed for the specified number of days.

 THIS MODE IS DISABLED BY DEFAULT - CONFIGURATION OF THE SYSTEM SHOULD BE MADE BY A QUALIFIED TECHNICIAN.

Service mode



It is recommended to put the system into the service mode before handing it to a service station or valet parking. When this mode is switched on, security system stops interfering with built-in electronics and disables all functions to ease maintenance.

To activate Service mode disarm the system  , turn on the ignition,  an authorization device (radio tag, remotes, watches, band) must be in the Bluetooth coverage zone. Deactivation of Service mode is carried out without conditions.



Use one of the methods described below. The confirmation of the executed command will be: Service mode is enabled - one long sound signal of a Siren 1x  and LED of the external button lights green while ignition is on ;

Service mode is disabled - two long sound signal of a Siren 2x  and LED of the external button faded while ignition is on.

 FOR THE SOUND NOTIFICATIONS IT IS NECESSARY TO MAKE AN ADDITIONAL SETTING (ASSIGN AN ADDITIONAL LOGIC «BEEPER» TO THE «SIREN» OUTPUT CHANNEL) – SETTINGS SHOULD BE MADE BY A QUALIFIED TECHNICIAN.



 **Radio tag** – to activate/deactivate Service mode, press and hold the button  on a radio tag until the third flash of the LED. The device must be in the Bluetooth coverage area.

 **Pandora Band (Smart Moto Plus kit)** – to activate/deactivate service mode, press and hold the button  for 3 seconds. The device must be in the Bluetooth coverage area.





 **Pandora Connect** – To activate/deactivate service mode, open the mobile application. When the system is online (there is an Internet or Bluetooth connection), press and hold the button  on the control panel until the scale is fully loaded. Activated Service mode is indicated by icon  it will disappear after deactivation.

 TO CHANGE THE LOCATION OF THE BUTTONS ON THE CONTROL PANEL GO TO THE APP SETTINGS AND ENTER THE «CONTROL BUTTONS» MENU.

 **Online service PANDORA-ON.COM** – to activate/deactivate Service mode when the system is online (there is Internet connection) choose command:

- For the Service mode activation choose «Switch on Service mode» and push «Send» button. Activated Service mode is indicated by icon .
- For the Service mode deactivation choose «Switch off Service mode» and push «Send» button. The icon  will disappear.

 **Phone** – call the system number wait for the answer and enter the command.

• To activate Service mode, dial the command  and then dial the «Secret PIN-code» from the Owner's personal card. The system will confirm the completed command with a voice notification «Command executed, function is switched on».

• To deactivate service mode dial the command . The system will confirm the completed command with a voice notification «Command executed, function is switched off».

CONTROL OVER THE SYSTEM IN CASE OF EMERGENCY

! BEFORE USING EMERGENCY SYSTEM CONTROL, CHECK THE SYSTEM AND VEHICLE CONTROL DEVICES: CHECK A BATTERY, TURN ON A DEVICE IN ACCORDANCE WITH ITS MANUAL (IF REQUIRED).

IF ALL DEVICES ARE WORKING, TRY TO MAKE A PRIMARY VEHICLE DIAGNOSIS: CHECK THE VEHICLE ORIGINAL CONTROL DEVICE, VEHICLE BATTERY CHARGE LEVEL, GEARBOX SELECTOR POSITION, CHECK INFORMATION ON THE DASHBOARD.

THE SYSTEM CAN BE CONTROLLED FROM A PHONE

Call the system phone number and enter the command after the answer:

0* – Disarming

998*xxxx – Deactivate authorization devices, where xxxx is the «Secret PIN- code» written on the Owner's personal card.

! THE PHONE NUMBER OF THE SYSTEM IS LOCATED UNDER THE PROTECTIVE LAYER ON THE «OWNER'S PERSONAL CARD». IF THE CALL IS MADE FROM THE «ADDITIONAL NUMBER», OR A NUMBER NOT SAVED IN THE MEMORY OF THE BASE UNIT, THEN AFTER THE SOUND SIGNAL, YOU WILL NEED TO ENTER THE «GUEST PIN CODE» (FACTORY VALUE IS 1-2-3-4). FOR A COMPLETE LIST OF COMMANDS, SEE THE SECTION «CONTROL THE SYSTEM BY A PHONE».

The system has emergency ways to deactivate security and Anti-Hi-Jack functions (using the VALET button and the «Secret PIN-code») in case of loss or failure of control devices or in case of discharge of a battery (when you cannot replace it or charge).

- «Secret PIN-code» is located under protective layer on the «Owner's personal card»;
- VALET button is located on the external VALET button or on the main unit.

Owner's personal card

REMOVE THE PROTECTIVE LAYER CAREFULLY. DO NOT USE ANY SHARP OBJECTS TO AVOID DAMAGING OF HIDDEN INFORMATION UNDER THE PROTECTIVE LAYER.

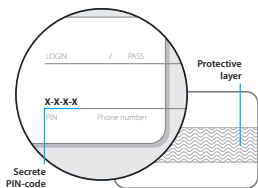

External VALET button

THE EXTERNAL VALET BUTTON IS PLACED IN THE INTERIOR (CHECK «SYSTEM MODULES LAYOUT»)

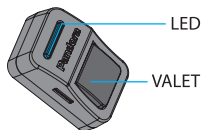

READ THE PROCEDURE FOR ENTERING THE PIN-CODE BEFORE USING EMERGENCY FUNCTIONS.

- **Enter the first digit** • Press the button the number of times equal to the first digit. Pauses between presses should not exceed 1 second. Each pressing will be confirmed with an orange LED indicator flash. Pause for more than 1 second, a red LED indicator flash confirm the input of the first digit. Then you can enter the next digit.
- **Enter the second digit** • Press the button the number of times equal to the second digit. Pauses between presses should not exceed 1 second. Each pressing will be confirmed with an orange LED indicator flash. Pause for more than 1 second, a red LED indicator flash confirm the input of the second digit. Then you can enter the next digit.
- **Enter the third digit** • Press the button the number of times equal to the third digit. Pauses between presses should not exceed 1 second. Each pressing will be confirmed with an orange LED indicator flash. Pause for more than 1 second, a red LED indicator flash confirm the input of the third digit. Then you can enter the next digit.
- **Enter the fourth digit** • Press the button the number of times equal to the fourth digit. Pauses between presses should not exceed 1 second. Each pressing will be confirmed with an orange LED indicator flash. The correct input will be confirmed with the series of green and red flashes of the LED indicator.

Emergency disarming

Not paying attention to the siren signals, make sure that the ignition is off and enter the «Secret PIN-code» (see the procedure description above). If there are no siren sounds or LED flashes, check the battery. It is not possible to enter the «Secret PIN-code», if there is no power supply.

- The system will be disarmed in case of correct PIN-code input. It will be confirmed with the series of green and red flashes of the LED indicator, the series of sound signals of the Beeper, 4 beeps of the Siren and 4 signals of the light signalization.
- Emergency disarming is equivalent to a normal method of disarming. No additional actions are required for further operation of the system.
- The system will stay in previous state in case of incorrect input of the PIN-code. It will be indicated with a long red flash of the LED indicator. New input can be attempted after 5 seconds.

Emergency control of the Code Immobiliser

This section describes two options to deactivate Immobiliser modes:

- Immobiliser and Anti-hi-Jack - use owner authorization devices (tags, remotes, watches, bands) for engine blocking;
- Code Immobiliser - uses standard vehicle controls (buttons, levers, pedals) to enter the Immobiliser PIN-code.

OPTION №1 – Emergency deactivation of the Code Immobiliser

To temporarily deactivate the Code Immobiliser (pin-to-drive) function, turn on the ignition when the system is disarmed and Service mode disabled. Enter the «Secret PIN-code» from the Owner's personal card using the VALE T button. The Immobiliser functions will be deactivated by the time the ignition is turned off.

OPTION №2 – Emergency control of the Code Immobiliser mode

This method is used for a permanent deactivation of the Code Immobiliser (pin-to-drive) function. Deactivation and activation is made by entering the «Secret PIN-code» from the owner's personal card using the VALET button while system is disarmed, ignition is off and the Service mode is disabled.

1. Enter the programming mode by entering the «Secret PIN-code» (from the Owner's personal card) or the «Service PIN-code» (factory preset is 1-1-1-1). The PIN-code should be entered using the external or located on the base unit VALET button.

2. Code Immobiliser enter the programming level №13 - press the VALET button 13 times (without pauses).

2. Immobiliser / Anti-hi-Jack - enter the programming level №15 - press the VALET button 15 times (without pauses).

3. To deactivate the function - The LED indicator will be green after entering the programming level. The system will wait 10 seconds for entering the «Secret PIN-code». If the PIN-code is not entered within 10 seconds or the input is incorrect, the LED will produce the series of red and green flashes and the system will return to the programming menu. Enter the «Secret PIN-code» that is written on the Owner's personal card. The system will confirm deactivating with a long red LED flash and two sound signals of the Siren. Turn on the ignition and then turn off to exit programming mode. The function will be deactivated.

4. To activate the function - The LED indicator will light red after entering the programming level. The system will wait for action. Press the VALET button once to activate the function. The system will confirm enabling with one short sound signal of the Siren and a green LED light. Turn on the ignition and then turn off to exit programming mode. The function will be activated.

PROGRAMMING THE SYSTEM

System settings and parameters can be configured using the Pandora Alarm Studio and Pandora Specialist application. Some functions can be configured only by the programming menu of the system. It is required to put the system to programming mode to get access to the settings.

Entering/exiting programming mode

You can enter the programming mode only if the base unit is powered form a USB cable or the main power supply is connected, the ignition is off, the system is disarmed and Service mode is off.

To enter programming mode, enter the «Service PIN-code» (default value is 1-1-1-1) using an external VALET button or the VALET button located on the base unit.

! IF YOU DON'T HAVE THE «SERVICE PIN-CODE», YOU CAN ENTER PROGRAMMING MODE USING THE «SECRET PIN-CODE» WRITTEN ON THE OWNER'S CARD. IT IS FORBIDDEN TO DAMAGE THE PROTECTIVE LAYER OF THE «OWNER'S PERSONAL CARD» - THE INFORMATION UNDER THE PROTECTIVE LAYER OF THE CARD IS INTENDED ONLY FOR THE OWNER OF THE SYSTEM. WHEN THE OWNER COMPLAINS ABOUT THE ERASED PROTECTIVE LAYER, THE SYSTEM IS REINSTALLED AT THE EXPENSE OF THE INSTALLER.

The system stops to execute commands when it is in programming mode. Therefore, exit programming mode after changing settings and parameters of the system.

To exit programming mode, use one of the following methods:

- Press and hold the VALET button for more than 10 seconds;
- Turn on and then turn off the ignition when a USB cable is disconnected and the main power supply of the system is connected;
- Disconnect the power supply (main and USB power supply).

The system will reboot programmatically (all changes will be saved) after exiting programming mode. All ways to exit programming mode are accompanied by sound signals of the siren and light signals of the LED indicator. The light signals indicate the number of paired control devices.

! SEE THE «CHECKING THE NUMBER OF PAIRED DEVICES SECTION OF THE USER MANUAL FOR DETAILED DESCRIPTION.

Pandora Specialist application

The Pandora Specialist mobile application (Android only) is available for system configuration:

- Download and install the Pandora Specialist mobile app (scan the QR-code or go to the Google Play app store);
- Connect the system and mobile device using USB cable or Bluetooth connection.



Bluetooth connection

- Enter the programming level №50;
- Open the mobile app, go to «Advanced mounting», when choose «Bluetooth»
- Choose the system in a search field;
- When changing the settings enter the «Service PIN-code» (default value is 1-1-1-1).

! AFTER THE SETTINGS WERE MADE DELETE THE MOBILE DEVICE FROM THE SYSTEM MEMORY BY ENTERING PROGRAMMING LEVEL №50

USB connection

- Connect the USB-OTG adapter to your smartphone or tablet;
- Connect the USB cable to the system;
- Connect the USB-OTG adapter to the USB cable;
- Open the mobile app, go to «Advanced mounting», when choose «USB-OTG»;
- Enter the «Service PIN» (default value is 1-1-1-1).

! USB-OTG ADAPTER IS NOT INCLUDED IN THE SET. CAN BE ORDERED SEPARATELY.

Pandora Alarm Studio

The Pandora Alarm Studio allows you to change the main settings and parameters of the system, update firmware, download installation manuals. A current version of the Pandora Alarm Studio can be downloaded from pandorainfo.com. The Pandora Alarm Studio is provided only to authorized installers of Pandora systems.

- Download the Pandora Alarm Studio to a PC with Windows XP/Vista/7/8/10.
- Run the Pandora Alarm Studio;
- Connect the system to the PC via a USB cable;
- Put the system to the programming mode;
- The Pandora Alarm Studio will automatically connect to the system and you will be able to configure settings and update firmware.

Updating firmware

It is recommended to update firmware of the base unit before installing and programming the system.

Pandora Specialist

- Open the «Check firmware» menu and select one of the update options («Download firmware» - upload firmware file from a server, «File manager» - upload previously downloaded to the device memory file);
- Select firmware and press the «Update» button to upload firmware to the base unit.

Pandora Alarm Studio

- Open the «Update Software» window and select one of the update options («Load from file» – upload firmware file from a PC folder, «Firmware archive» – upload firmware from a server to «Firmwares» folder);
- Select firmware and press the «Update» button to upload firmware to the base unit.

It is required to exit programming mode after settings were changed or firmware was updated.

! IF THE BOOT MODE HAS BEEN INTERRUPTED FOR SOME REASON AND THE STATUS INDICATOR LIGHTS RED, YOU NEED TO LOAD FIRMWARE USING QUICK BOOT MODE (WITHOUT ENTERING THE PIN-CODE). OPEN THE PANDORA ALARM STUDIO OR PANDORA SPECIALIST APPLICATION; DE-ENERGIZE AND DISCONNECT THE SYSTEM; PRESS AND HOLD THE VALET BUTTON LOCATED ON THE BASE UNIT; RELEASE THE BUTTON IMMEDIATELY AFTER CONNECTING THE USB CABLE; THE SYSTEM WILL ENTER BOOT MODE.

Programming table

FUNCTION	VALET BUTTON		
	Level	Delete	Update
№0 – Entering a level	Level	Delete	Update
№2 – Changing the Service PIN-code	P2		
№4 – Reset to the factory settings	P4	H4	
№10.1.1 – Pairing a radio tag BT760 / BT770 / BT780	H1→P1→P1	H3	
№10.1.2 – Pairing a radio tag BT760 / BT770 / BT780	H1→P1→P2	H3	
№10.1.3 – Pairing a radio tag BT760 / BT770 / BT780	H1→P1→P3	H3	
№10.2.1 – Pairing a D030 / D035 / Band / Watch2	H1→P2→P1	H3	
№10.2.2 – Pairing a D030 / D035 / Band / Watch2	H1→P2→P2	H3	
№10.2.3 – Pairing a D030 / D035 / Band / Watch2	H1→P2→P3	H3	
№10.3.1 – Pairing a door sensor DMS-100BT	H1→P3→P1	H3	H5
№10.3.2 – Pairing a door sensor DMS-100BT	H1→P3→P2	H3	H5
№10.3.3 – Pairing a door sensor DMS-100BT	H1→P3→P3	H3	H5
№10.3.4 – Pairing a door sensor DMS-100BT	H1→P3→P4	H3	H5
№10.4.1 – Pairing a radio relay BTR-101	H1→P4→P1	H3	H5
№10.4.2 – Pairing a radio relay BTR-101	H1→P4→P2	H3	H5
№10.6 – Pairing an additional device RHM-03BT / PS-331BT / PS-332BT	H1→P6	H3	H5
№10.7 – Pairing an additional device	H1→P7	H3	H5
№10.8 – Pairing a telemetry module Pandora Eye Pro / NAV-X	H1→P8	H3	
№10.9 – Pairing a GPS-receiver NAV-035 BT	H1→P9	H3	H5
№10.11 – Pairing an RF module RFM-470	H1→P11	H3	H5
№11 – Programming and configuring an «Immobiliser PIN-code»	H1.P1		
№13 – Emergency deactivating/activating code Immobiliser function (pin-to-drive)	H1.P3		
№15 – Emergency deactivating/activating authorization devices (Immobiliser, Anti-hi-Jack)	H1.P5		
№50 – Pairing a mobile phone	H5		
№100 – Exit the programming menu	H10		

P – press **X** times

H – hold for **X** sec

→ – 1 sec pause

• – without a pause

Level №0 – Entering a level

Enter programming mode, enter the «Service PIN-code» (default value is 1-1-1-1) using an external VALET button or the VALET button located on the base unit. After entering programming mode, the system waits for level input – «Level 0 Entering a level». Enter a desired level using the VALET button (see the programming table) to change settings or parameters:

- To enter a level («Level №1...№17»), press (P) the VALET button the number of times equals to the desired level number (1...17), pauses between presses should not exceed 1 second. The system will confirm correct input with red LED flashes and short sound signals of the Siren and proceed to the desired level.
- For quick access to the higher level, press and hold (H) the VALET button. The siren will sound tone beeps (up to 10). These sounds mean the sequence number of a two-digit level number (the first signal – level №10, the fifth signal – level №50, the tenth signal – level №100). Release the VALET button immediately after the desired number of signals. To enter an intermediate level (Level №11...№18), press the VALET button the number of times equals to the second digit (1...8) of the desired level number immediately after releasing the button. The system will confirm correct input with red LED flashes and short sound signals of the Siren and proceed to the desired level.

Level №2 – Changing the Service PIN-code

Prepare a new value of the «Service PIN-code», it should consist of 4 digits (from 1 to 9). Write down or remember the new PIN-code.

Enter the programming level №2:

- Enter the first digit of the code using the VALET button. Press the button the number of times equals to the first digit. Pauses between presses should not exceed 1 second, every pressing will confirm with an orange LED indicator flash. Pause for more than 1 second and a red LED indicator flash with a sound from the Siren confirm the input of the first digit. Then you can enter the next digit;
- Enter the other numbers in the same manner. The input of the fourth number will be confirmed by the series of red and green LED indicator flashes and the series of sound signals of the Siren. The system will wait for PIN-code re-entering;
- Enter all four digits again.
- If you correctly enter the «Service PIN-code» twice, the indicator will produce the series of red and green flashes and the Siren will produce the series of sounds, the new PIN-code will be recorded, the system will return to the programming level №0.
- In case of the incorrect code, input the indicator will be lit red and the Siren will sound a long beep, the system will not change the code and will return to the programming level №0.

Level №4 – Reset to the factory settings

The procedure recovers the factory settings of the system without deleting previously registered devices (tags, mobile device, relays, etc.) that is stored in the non-volatile memory.

Enter the programming level №4:

- Press and hold the VALET button for more than 4 seconds. Release the button after a sound of the Siren. The system will confirm the resetting to the factory settings with a long red flash of the LED indicator. After that, the system will reset the settings to default and return to the programming level №0.

Level №10 – Manage Bluetooth devices / Firmware Update

! ALL ADDITIONAL DEVICES INCLUDED IN THE SYSTEM SET ARE PAIRED WITH THE SYSTEM. THE MAXIMUM NUMBER OF PAIRED BLUETOOTH DEVICES MUST NOT EXCEED 14.

ALL FUNCTIONS OF THIS LEVEL ARE AVAILABLE IN THE PANDORA SPECIALIST APP WHEN USING A BLUETOOTH CONNECTION.

FOR THE MANAGEMENT OF THE ADDITIONAL DEVICES GO TO «ADVANCED MOUNTING» -> «PAIRING/UNPAIRING DEVICES».

FOR THE FIRMWARE UPDATE OF THE ADDITIONAL DEVICES GO TO «ADVANCED MOUNTING» -> «SYSTEM DEVICES».

FOR A DETAILED DESCRIPTION OF PAIRING PROCEDURE FOR SPECIFIC DEVICE CHECK IT'S MANUAL ON WWW.PANDORAINFO.COM.

This level is used to pair/remove/update additional devices of the system. Each device is paired at a sublevel. To pair devices of the same type, a sublevel is divided into cells. To enter a sublevel or a cell of sublevel make a pause for more than 1 second, then press (P) the VALET button the number of times equals to the desired sublevel or cell number: «Level №10» (1sec) «Sublevel 1...10» (1sec) «Cell of sublevel 1...4».

PAIRING/DELETING AN ADDITIONAL DEVICE

Each sublevel or cell displays it's current state by a color of the LED: green light means the system is ready for pairing, red light means a device has been already paired and it is required to delete it for pairing a new device. To delete a device, press and hold the VALET button for 3 seconds (4 orange flashes of the LED, or 3 sound signals of the Siren). The system will be in pairing mode for 1 minute. After a minute or immediately after pairing a device, the system will automatically enter the programming level №0.

PAIRING RADIO TAGS BT760/BT770/BT780

- Enter the programing level №10.1.1...3.
- If the LED is green, the system is ready for pairing.

- Press and hold button on a tag until the 6 flashes of the tag status indicator, release the button;
- The system will confirm pairing with a sound signal from the Siren and the LED will light red.
- The system will enter the programming level №0.

PAIRING PANDORA BAND

- Enter the programming level №10.2.1...3.
- If the LED is green, the system is ready for pairing.
- Press and hold button on the Band for 6 seconds;
- The system will confirm pairing with a sound signal from the Siren and the LED will light red.
- The system will enter the programming level №0.

PAIRING DOOR SENSOR DMS-100 BT

- Enter the programming level №10.3.1...4.
- If the LED is green, the system is ready for pairing.
- Open the plastic case of the sensor carefully and insert a battery inside.
- The system will confirm pairing with a sound signal from the Siren and the LED will light red.
- The system will enter the programming level №0.

PAIRING A SIREN PS-332 BT

- Enter the programming level «Pairing an additional device RHM-03BT/PS-331BT/PS-332BT» (level №10.6);
- System is ready for pairing, the LED lights green;
- Put a magnet on the selected zone and connect the power supply, the siren will be paired with the system;
- The system will confirm pairing with a sound signal from the Siren and the LED will light red.
- The system will enter the programming level №0.

UPDATING FIRMWARE OF AN ADDITIONAL DEVICE

- To update firmware of an additional device, enter the «Level №10» «Sublevel» or «Cell» corresponding to an additional device. The LED will light red after entering. Press and hold the VALET button for 5 seconds until 6 orange flashes of LED indicator or 5 sound signals of the Siren. Open the Pandora Specialist or Pandora BT app, go to «Search device» screen and select the device and then select one of the update options:
- INTERNET – It allows you to upload firmware from a server.
- FILE MANAGER – This function is available only for Android devices. It allows you to upload firmware from the phone storage.

Level №11 – Programming and configuring an «Immobiliser PIN-code»

The level is divided into 3 sublevels

Selecting buttons

The system will automatically enter the sublevel 11.0 (Selecting buttons) after entering the level 11. The system will wait for buttons pressing. Each pressing will be confirmed with an orange flash of the LED. You can turn on the ignition (the system will stay in programming mode). The system can determine buttons via analog «Code Immobiliser 1» and «Code Immobiliser 2» inputs.

After selecting active buttons, press the VALET button to enter the sublevel 11.1 (Entering the PIN-code).

Entering the PIN-code

Program the Immobiliser deactivation PIN-code using the selected button or buttons on this sublevel. The code can consist of one or more memory cells, each memory cell can store a sequence of pressing each of the selected Immobiliser buttons.

The code is entered by pressing the selected buttons for at least 1 second. Each pressing is confirmed with an orange flash of the LED. A pause for more than 1 second and the red LED confirms the input for the current memory cell, you can start entering the next memory cell. After entering the code, press the VALET button to enter the next sublevel 11.2 (Confirmation of the PIN-code input).

Confirmation of the PIN-code input

- Confirm the entered PIN-code on this sublevel. Repeat the procedure described above and press the VALET button. The system will compare two inputs after that.
- If you correctly enter the code twice, the indicator will produce the series of red and green flashes and the Siren will produce the series of sounds, the new code will be recorded, the system will return to the programming level №0.
- In case of the incorrect code input the indicator will be lit red and the Siren will sound a long beep, the system will not change the code and will return to the programming level №0.

Level №13/№15 – Emergency deactivating/activating authorization devices and functions

See the detailed description in the «Control of the system in case of emergency» section.

Level №50 – Pairing a mobile phone

See the detailed description in the «Mobile application» section.

Level №100 – Exit the programming menu

To exit the programming menu, press and hold the VALET button for more than 10 seconds until the tenth sound signal of the Siren or until a red flash of the LED. The system will exit programming mode and will reboot programmatically.

ADDITIONAL DEVICES

Remote control D-035 – is a two-way short-distance communication device designed to control a security system and receive information about its state. The remote control can be used as an owner authorization device.

CONTROL COMMANDS

Arming/Disarming | Service mode

STATUSES

Vehicle and system statuses

OWNER AUTHORIZATION

Immobiliser | Anti-Hi-Jack | Hands Free

OLED-DISPLAY | 2.4GHz RADIO INTERFACE (BLE 5.0) | THREE CONTROL BUTTONS |
SOUND INDICATOR | VIBRO INDICATOR | LED INDICATOR | BATTERY | MICRO-USB | IP40



Radio tag BT-760 / BT-770 / BT-780 – is a one-way short-distance communication device designed to control a security system. The tag can be used as an owner authorization device.

CONTROL COMMANDS

Arming/Disarming | Service mode

OWNER AUTHORIZATION

Immobiliser | Anti-Hi-Jack | Hands Free

2.4GHz RADIO INTERFACE (BLE 4.2) | CONTROL BUTTON | LED INDICATOR | MOTION
SENSOR | CR2032 BATTERY | IP40



Piezo siren PS-331 BT / PS-332 BT is a wireless device for sound signalization.

PS-331 BT:

SOUND PRESSURE 105-118 dB | 2,4 GHz (BLE 4.2) RADIO INTERFACE | FLEXIBLE INPUT
| FLEXIBLE OUTPUT | TEMPERATURE SENSOR | CONTROL OF CONNECTION WITH A MAIN UNIT
| 300 mA, 12V | IP65

PS-332 BT:

SOUND PRESSURE 105-118 dB | 2,4 GHz (BLE 4.2) RADIO INTERFACE | CONTROL OF
CONNECTION WITH A MAIN UNIT | 300 mA, 12V | IP65



WARRANTY OBLIGATIONS

Manufacturer guarantees correct operation of the service-security system if exploitation, installation, storage and transportation conditions described in this manual were met.

The system should only be used according to installation scheme and user manuals.

The system is meant to be installed by the professional car electronics installers. The installer should fill in installation certificate that is included in this manual.

Parts malfunctioning during warranty period on the fault of the manufacturer should be repaired or replaced by the installation center of the manufacturer or by certified service center. List of certified service centers can be found on pandorainfo.com

The user loses the right for warranty services in the following cases:

- when warranty period expires;
 - if exploitation, installation, storage or transportation conditions were not met;
 - if there is mechanical damage of the external parts of the system after it is sold.
- This includes: fire damage, consequential damage in case of car accident, aggressive liquids and water seeping damage, damage caused by improper use;
- if the damage was caused with incorrect settings and parameter adjustment;
 - if system devices are replaced with any devices that are not recommended by the manufacturer;
 - if manufacturer sealing is broken;
 - if there is no properly filled warranty card and installation certificate.

Warranty period is 3 years since the moment of purchase, but no more than 3.5 (three and a half) years since the moment of production. This warranty does not include batteries of the remotes, as they have their own service lifetime.

Maintenances and repairs of the system with expired warranty period are carried out at the expense of the user on a separate contract between the user and the installer/service center.

 WE RECOMMEND THAT YOU ASK AN INSTALLER TO FILL OUT THE INSTALLATION CERTIFICATE AND THE WARRANTY CARD. THESE DOCUMENTS MAY BE REQUIRED FOR CONTACTING THE CUSTOMER SUPPORT.

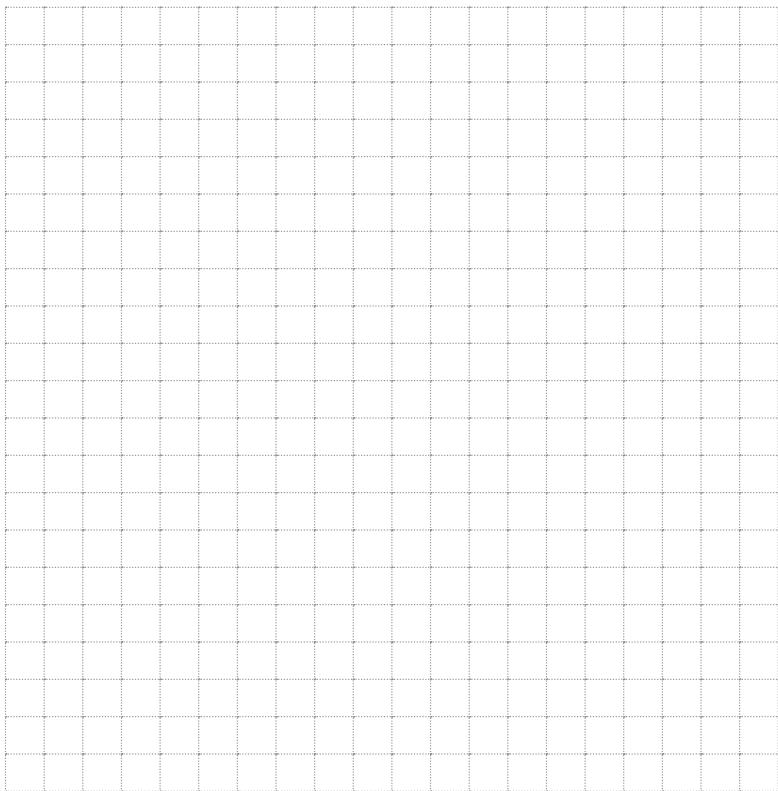

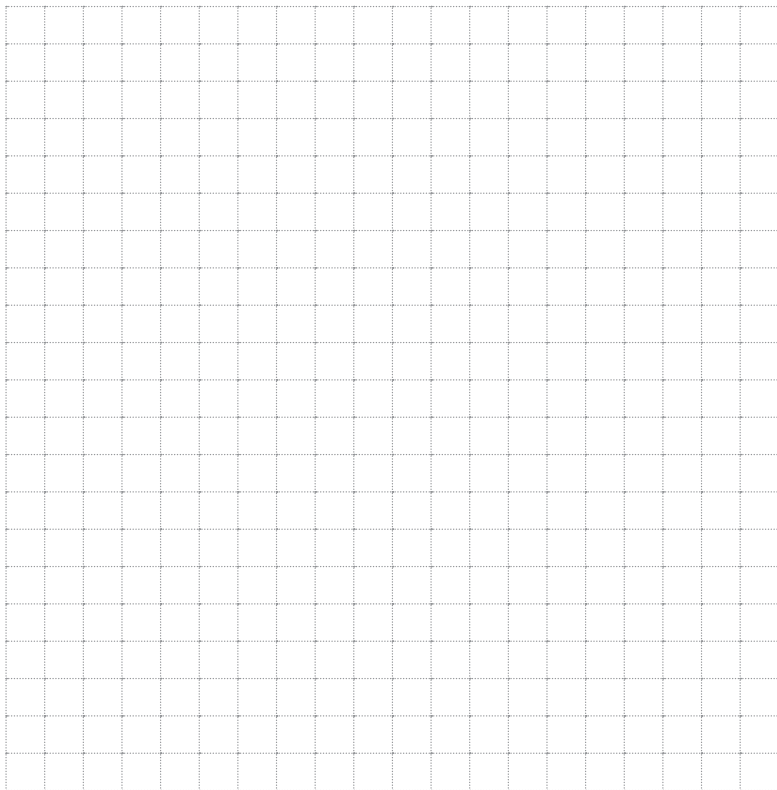

Installation certificate

I, the undersigned _____
Position, name

professional installer, certify that installation of the service-security system, specified below, was carried out by me in accordance with manuals and schemes provided by the manufacturer.
Car specifications:

Car model _____

Type _____

Id number (VIN) _____

Registration number _____

Security system specification: _____

Model Pandora Smart Moto / Pandora Smart Moto Plus _____

Serial number _____

Service center name, full address and installer's stamp _____

Signature _____ / _____ /
Signatory

Work accepted _____ / _____ /
Signatory

Date « ____ » _____ 20 ____ y.

Acceptance certificate

Model **Pandora Smart Moto / Pandora Smart Moto Plus** is in conformity with Electromagnetic Compatibility Directive EMC 2004/108/EC and R&TTE Directive 1999/5/EC.

Serial number _____ Date of production _____

Responsible person's signature (stamp)

Packager _____

Signature (personal stamp) _____

Warranty card

Model **Pandora Smart Moto / Pandora Smart Moto Plus**

Serial number _____

Date of purchase « ____ » _____ 20 ____ year

Seller's (installer's) stamp

Seller's signature