

Pandora would like to thank you for choosing our service-security system

Pandora Light Pro – is a car service-security system built for cars with on-board voltage of 12V. It is a complex engineering solution, which includes unique and modern technological software and hardware solutions.

When building the **Pandora Light Pro** we were using the most up-to-date electronics from world's best manufacturers. The device is built using high-precision mounting and control machinery, thus we guarantee highest possible quality, reliability and stable technical characteristics for the whole operation period.

Pandora Light Pro has a cryptographically strong authorization code with unique dialog algorithm and individual 128 bit encryption key on every device. We guarantee 100% protection from electronic hacking for the whole operation period.

The system is built for your convenience: it's ergonomic, reliable, has the highest security and service characteristics, 3 years unconditional warranty and free service and support. We are happy to provide any support we can – feel free to use our online support.

WARNING! It is strongly advised to have professional car mechanic installing the system. Any car electronics installer should be able to install Pandora Light Pro using installation scheme in this manual and AlarmStudio software. Most features are highly dependent on competent installation. Our systems are thoroughly tested for quality, so if a feature fails to produce expected result, most likely the problem is in improper installation.

This device has limited external factors resistance. It should not be subjected to water beyond occasional splatter, or operated in temperatures outside -40 to +85° C range. All system components must be installed only in a car interior. The base unit, remote control and radio tags fulfil with the IP40 category of protection against water.

**Our web-site: pandorainfo.com
Customer support: support@pandorainfo.com**



Table of contents

| | |
|--|-----------|
| System set | 4 |
| System features | 4 |
| Base unit | 4 |
| Control | 5 |
| Immobilizer mode | 6 |
| Anti-Hijack mode | 6 |
| Multi-button code immobilizer (pin-to-drive) | 7 |
| Remote control (D022) | 8 |
| Switching on/off the remote control | 8 |
| LED indicators meaning | 8 |
| Quick access functions of the remote control | 9 |
| Icons of the remote control | 11 |
| Menu of the remote control | 13 |
| Immobilizer radio tag | 18 |
| Replacing an immobilizer tag battery | 18 |
| Mobile applications | 19 |
| Control over the system | 22 |
| Arming | 22 |
| Disarming | 23 |
| Unlocking a trunk | 25 |
| Locking/unlocking doors when ignition is on | 25 |
| Delayed arming | 26 |
| Car search function | 26 |
| Panic mode | 26 |
| Remote and automatic engine start | 27 |
| Program neutral procedure (reservation mode) | 27 |
| Remote engine start | 28 |
| Automatic engine starts | 29 |

| | |
|---|-----------|
| Service mode | 29 |
| Control over the system in case of emergency | 31 |
| Emergency disarming | 31 |
| Emergency disabling immobilizer radio tags | 32 |
| Deactivating code immobilizer (pin-to-drive) | 33 |
| Additional information | 34 |
| Siren sounds and light signalizations | 34 |
| Beeper sound signals | 34 |
| Meaning of the LED indicator colors | 35 |
| Checking the number of recorded radio tags | 35 |
| System module layout | 36 |
| Warranty obligations | 37 |
| Installation certificate | 38 |
| Acceptance certificate | 39 |
| Warranty card | 39 |

SYSTEM SET

| | |
|---------------------------------|---|
| 1. Base unit | 1 |
| 2. Owner's personal card | 1 |
| 3. Remote control | 1 |
| 4. Radio tag | 1 |
| 5. User manual | 1 |
| 6. External "LED/VALET» button | 1 |
| 7. Beeper | 1 |
| 8. Analogue temperature sensor | 1 |
| 9. Blocking relay | 1 |
| 10. Main cable of the base unit | 1 |
| 11. IMMO-KEY interface cable | 1 |
| 12. LIN-interface cable | 1 |
| 13. Micro-USB cable | 1 |
| 14. Fastening kit | 1 |
| 15. Packaging | 1 |

NOTE! THE MANUFACTURER RESERVES THE RIGHT TO CHANGE THE SYSTEM SET AND CONSTRUCTION OF THE PRODUCT TO IMPROVE ITS TECHNOLOGICAL AND OPERATIONAL PARAMETERS WITHOUT NOTIFICATION.

SYSTEM FEATURES

Base unit

- Integrated 868 MHz radio interface
- Integrated 2.4 GHz module with support of Bluetooth 5.0 Low Energy protocol
- Dialog coding of control commands with an individual 128-bit encryption key (the key is changed every time you re-record a peripheral device)
- Built-in integral accelerometer for determining motion and shocks with adaptive processing algorithm and sensitivity adjustment.
- Built in temperature sensor, additional engine temperature sensor
- Integrated port and algorithms for bypass of original immobilizers
- Built-in micro-USB port
- Individual "Secret PIN-code", changeable "Service PIN-code" and "Immobilizer PIN-code".

Control

Control of the vehicles zones depends on the type of connection and system settings, original car operation and trim.

TYPE №1 Analog connection – It is a direct connection of analog inputs and outputs to electrical circuits of a vehicle in accordance with a connection diagram.

TYPE №2 Digital connection – It is a connection to digital (CAN, LIN) buses. It allows reading information (statuses) and controlling vehicles (commands) by digital buses of the vehicles. The detailed information about digital protocols is available on loader.pandorainfo.com. The declared statuses may not be available for certain vehicle trims.

TYPE №3 Built-in sensors – These sensors are integrated in the base unit. The sensors perform control and protection of the vehicle. Additional connections are not required.

TYPE №4 Additional sensor (*optional) – External additional sensors are connected to the base unit.

| TYPE | | | | Protected and monitored zones |
|------|----|----|----|--|
| №1 | №2 | №3 | №4 | |
| | • | • | •* | Interior temperature (status) |
| | • | | • | Engine temperature (status) |
| | • | | •* | Outside sensor (status) |
| | | • | | Voltage of the on-board circuits (status, security zone – alarm level) |
| | | • | | Shock sensor (security zone – alarm and warning level) |
| | | • | | Motion sensor (security zone – alarm level) |
| | | • | | Tilt sensor (security zone – alarm level) |
| | • | | •* | OE alarm system status via CAN, additional sensor, (status, security zone – alarm and warning level) |
| • | • | | | Turning ignition on (status, security zone – alarm level) |
| • | • | | | Opening doors, separate indication for each door via CAN (status, security zone – alarm level) |
| • | • | | | Opening a trunk (status, security zone – alarm level) |
| • | • | | | Pressing brake (status, security zone – alarm level) |
| • | • | | | Engine operation control - RPM (status) |

| | | | | |
|---|---|--|--|--|
| • | • | | | Position of a gearbox selector/handbrake(status) |
| | • | | | "Parking light is not turned off" notification |

| №1 | №2 | №3 | №4 | Control (commands) |
|----|----|----|----|---------------------------|
| • | • | | | Central lock |
| | • | | | Car original alarm system |
| • | • | | | Trunk |
| • | • | | | Turn lights |
| • | • | | | Closing windows |
| • | • | | •* | Engine pre-heater |

Immobilizer mode

When switching on the ignition, a base unit of the security system performs a search for immobilizer tags in the radio coverage zone. If no radio tags are detected at the time of switching on the ignition, the system will block the engine. Engine blocking will occur immediately or at the time a motion sensor detects movement, it depends on the system settings.

This mode is enabled by default. Use the mobile app or Pandora AlarmStudio to disable it.

WARNING! IF THE SYSTEM DOES NOT RECOGNIZE A RADIO TAG, THE BEEPER WILL EMIT 5 SOUND SIGNALS WHEN THE IGNITION IS TURNED ON, THIS WILL REPEAT 5 TIMES. CHECK A RADIO TAG BATTERY, MOVE A TAG (IT GOES TO THE SLEEP MODE WHEN IT REMAINS MOTIONLESS AND THE IGNITION IS OFF. A BUILT-IN ACCELEROMETER HAS TO RECOGNIZE MOVEMENT TO ACTIVATE A TAG).

Anti-Hijack mode

The Anti-Hi-Jack mode helps to prevent aggressive seizure of a car using delayed engine blocking on door opening. Every time on opening/closing a door when the ignition is on, the system requests a response from a radio tag using a unique algorithm. After a door was opened while the ignition is on, if the system cannot detect a radio tag, the engine will be stopped after 1 minute (general safety requirement). The siren will play the 'ENGINE BLOCKING WARNING' ringtone before blocking. The engine will be blocked immediately or at the time the car starts moving, it depends on system settings. Blocking will be disabled if the system detects a radio tag.

This mode is disabled by default. Use the mobile app or Pandora AlarmStudio to enable it.

Anti-Hijack 2 mode

The Anti-Hi-Jack-2 mode helps to prevent aggressive seizure of a car using delayed engine blocking on radio tag disappearance. The system constantly requests a response from a tag using a unique algorithm when the ignition is on. If the system cannot detect a radio tag, the engine will be stopped after 1 minute (general safety requirement for car movement). The siren will play the 'ENGINE BLOCKING WARNING' ringtone before blocking. When warning signals end, the system will block the engine. Engine blocking will occur immediately or at the time the car starts moving, it depends on block implementation and system settings.

This mode is disabled by default. Use the mobile app or Pandora AlarmStudio to enable it.

Multi-button code immobilizer

Multi-button code immobilizer (pin-to-drive) is a function that allows disarming, disabling blocking and controlling service mode and time channels using original vehicle controls (button, lever or pedal) and a pre-programmed PIN-code (the "Immobilizer PIN-code"). The function works using special analog inputs or digital buses of a car.

An example of using the function:

- Turn on the ignition to disable engine blocking or enable service mode, turning on the ignition is not required if you want to disarm the system or control time channels.
- Enter the "Immobilizer PIN-code". Press a programmed button/lever/pedal the number of times equals to the first digit. Pauses between presses should not exceed 1 second. More than 1 second pause will be interpreted as the start of the next digit input. The immobilizer code can consist max of 4 digits from 1 to 9.
- The system will confirm the correct input by a sound signal of the beeper and a programmed function will be performed.

NOTE! IT IS REQUIRED TO MAKE ADDITIONAL CONNECTIONS AND SETTINGS TO USE THIS FUNCTION.

REMOTE CONTROL (D022)

A two-way remote control is the main mean of control over the system.

For easily distinguishable notifications the remote uses 16 ringtones. Each ringtone matches particular event. Remote has flashing LED indicators for additional information.

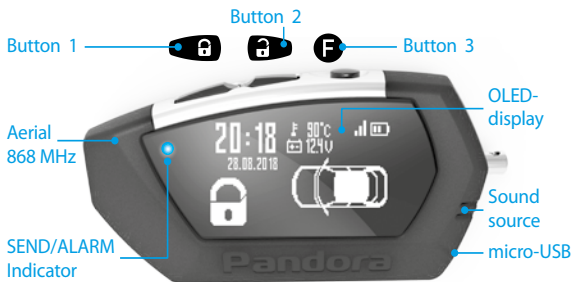

NOTE! A REMOTE CONTROL IS A UNIFIED CONTROL DEVICE. ITS FUNCTIONS DEPEND ON SECURITY SYSTEM MODEL.

Switch on/off the remote control

The remote is fully operational when shipped. To switch on the remote, press and hold the **F** button for 3 seconds. The “REMOTE ON” ringtone will play. Pressing and holding this button again for 3 seconds will cause the remote to switch off.

ATTENTION! ALL CONTROL COMMANDS ARE TRANSMITTED VIA RADIO CHANNEL, FOR MAXIMUM EFFECTIVENESS AND RANGE IT IS RECOMMENDED NOT TO SHIELD AERIAL AREA (SEE PICTURE) WITH FINGERS WHEN USING A REMOTE CONTROL.

LED indicator signals







Green indicator:











- Flashes if there is a connection with the base unit
- Goes dark when there is no connection with the base unit

Red indicator:



















- Flashes frequently if there is any notification
- Flashes occasionally when there is no connection

Quick access functions of the remote control

| | System is disarmed | | System is armed (no alarm events) |
|---|--|-----------------------------------|---|
| | Ignition is switched on | Ignition is switched off | |
|  (short press) | Lock doors without arming | Arming with sound confirmation | Search mode – flashes of turn signals with sound signals for 5 seconds |
|  (1 sec.) | | Arming without sound confirmation | Search mode – flashes of turn signals without sound signals for 5 seconds |
|  (2 sec.) | Switch on 'Ignition maintenance' mode | | |
|  (3 sec.) | Switch on "Program neutral" (reservation mode) | | Remote engine start |
|  (short press) | Unlock doors | Unlock doors | Disarming with sound confirmation |
|  (1 sec.) | | | Disarming without sound confirmation |
|  (2 sec. and more) | Switch off 'Ignition maintenance' mode | | Switch off the ignition during remote or automatic engine start procedure |



| | | | |
|--|--|---|--|
|  (short press) | Switch on LCD lighting (available only on the remote with LCD) | | |
|  (1 sec.) | Unlock trunk (CH1) | | |
|  (2 sec.) | Switch on/off timer channel (CH2) | | |
|  (3 sec.) | Switch on/off remote (available only on the remote with LCD) | | |
|  +  (short press) | PANIC mode | | |
|  +  (short press) | Arming when the engine is running with sound confirmation | Arming in 30 seconds with sound notification | |
|  +  (1 sec.) | Arming when the engine is running with sound confirmation | Arming in 30 seconds without sound notification | |

Icons of the remote control

-  Flashing when command sending
-  Security mode status
-  Remote control battery level
-  Current time
-  Battery voltage
-  Interior temperature
-  Engine temperature
-  Fuel level
-  Ignition security zone
-  Shock sensor security zone:
Warning level
-  Alarm level
-  Tilt sensor security zone
-  Motion sensor security zone
-  Doors security zone*
-  Front hood security zone
-  Trunk security zone
-  Low voltage security zone
-  Handbrake/neutral indicator, Brake pedal
-  Engine operation icon

* Separate display indication of doors, original alarm status, fuel level depend on information in CAN-bus digital protocol of specific car

Charging the remote control

- Battery is charged 
- Battery is discharged 

There is battery charge level indication on the display of the remote control. Charge the battery if the remote control doesn't turn on or the charge indicator displays low level. Charging is performed using a standard micro-USB cable.



Firmware update

- Run the Pandora Alarm Studio application on a PC and connect a USB-cable to it.
- Press and hold the , button and connect a USB cable. Release the button after connection. The remote control and the app will enter boot mode.
- Upload firmware, disconnect the USB-cable after completion of the procedure.

NOTE! THE ALARMSTUDIO APPLICATION IS PROVIDED ONLY TO AUTHORIZED INSTALLERS OF PANDORA. IT IS AVAILABLE ON OUR WEB-SITE PANDORAINFO.COM

REMOTE CONTROL MENU

You can control and manage all main settings and parameters of the system using the menu of the remote control.

Briefly press the **F** button to enter the menu. The following presses of the **F** button will switch between menu items. Press the  or  button to enter a selected item.

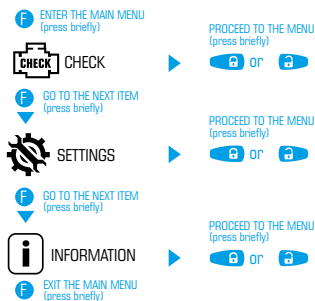

Check menu

To get information about engine temperature, interior temperature, battery voltage and fuel level, select the CHECK menu by short presses of the **F** button and briefly press the  or  button.

If there are no any actions within 5 seconds, the remote control will exit the main menu automatically. You can manually exit the menu by pressing the **F** button.

12.4V



Battery
Voltage

90°



Engine
temperature

22°





Interior
temperature

55%





Fuel
level

Settings

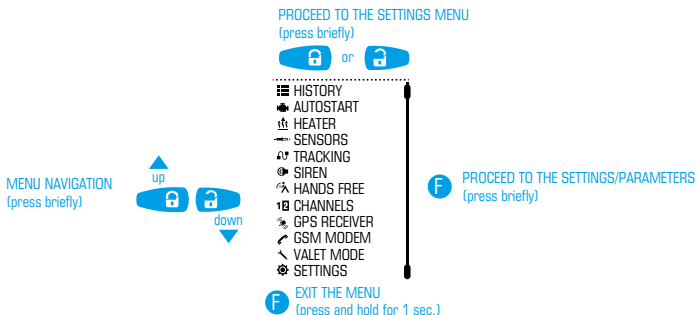
To change settings and parameters of the system, select the SETTINGS menu by short presses of the **F** button and briefly press the  or  button.



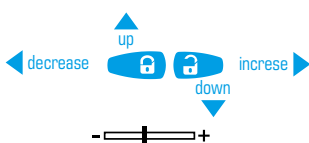

Shortly press  or  buttons to select a sub-menu. To enter a sub-menu, briefly press **F** button.

navigation buttons



Enter/confirmation button



a parameter is disabled   a parameter is enabled

HISTORY VIEW EVENT HISTORY

This menu allows viewing the event history stored in the remote control memory. The remote control displays an event name and its time.

NOTE! THE NUMBER OF EVENTS IS LIMITED BY THE MEMORY OF THE REMOTE CONTROL. USE OUR INTERNET SERVICE TO VIEW MORE DETAILED EVENT HISTORY.

AUTOSTART AUTOMATIC ENGINE START SETTINGS

This menu allows configuring the automatic engine start and stop settings. A synchronized real-time clock in the remote control and the base unit and other autonomous system settings allow to implement set of conditions of engine start and operation regardless of whether the remote control is in the radio coverage zone or not.

NOTE! IF YOU HAVE NOT SAVED NEW SETTINGS, REMOTE AND AUTOMATIC ENGINE START SETTINGS WILL REMAIN THE SAME AS BEFORE. ENGINE START VIA TEMPERATURE IS AVAILABLE ONLY IF TEMPERATURE SENSOR IS CONNECTED. AUTOMATIC ENGINE START SETTINGS DON'T AFFECT REMOTE ENGINE START FUNCTIONS.

- **ENABLE** - this submenu switches on/off all automatic engine starts.
- **TIMER** - this submenu allows starting an engine every day at the scheduled time.
- **START TEMP** - this submenu allows starting an engine automatically when the engine temperature is low.
- **WORK TIME** - This submenu determines the maximum engine operation time for automatic and remote starts.
- **PERIODICALLY** - this submenu allows starting engine periodically with a configured time interval.
- **STOP TEMP** - this submenu determines the engine stop temperature.



HEATER CONTROL OVER AN ENGINE PREHEATER

This menu allows switching on/off an engine pre-heater.

SENSORS SETTINGS AND ADJUSTMENT OF THE SENSORS

This menu allows controlling and adjusting sensors (shock/motion/tilt) sensitivity. SHOCK and additional EXTERNAL sensors have separate sensitivity zones. Alarm zone triggers when there are considerable impact on a sensor. If the alarm zone is triggered, the system will indicate it with light and sound alarm for 30 sec. Warning zone triggers when there are minor impact on a sensor (the sensitivity of the warning zone should be higher than the alarm level sensitivity for correct operation). Warning level is indicated by

one light and three sound signals.

• **SHOCK** — This submenu allows adjusting sensitivity of the alarm  and warning  zones of the shock sensor.

 - Warning and alarm zones are enabled

 - Warning and alarm zones are disabled

 - Warning zone is disabled

• **MOTION** — This submenu allows adjusting sensitivity of the motion sensor



 - Motion sensor is enabled

 - Motion sensor is disabled

• **TILT** — This submenu allows adjusting sensitivity of the tilt sensor

 - Tilt sensor is enabled

 - Tilt sensor is disabled

• **EXTERNAL** — This submenu allows adjusting sensitivity of the alarm  and warning  zones of the additional sensor.

 - Warning and alarm zones are enabled

 - Warning and alarm zones are disabled

 - Warning zone is disabled

TRACKING THIS FUNCTION IS NOT AVAILABLE FOR THE SYSTEM

SIREN OPTIONS OF SIREN SOUND SIGNALS

This menu allows configuring siren sound notifications.

 - All sound signals are enabled

 - Warning signals are disabled

 - Warning and alarm signals are disabled

HANDS FREE SETTINGS OF THE HANDS FREE MODE

This menu allows configuring the Hands Free mode for arming/disarming.

 - Enable arming in the Hands Free mode

 - Enable disarming in the Hands Free mode

 - Enable arming and disarming in the Hands Free mode

CHANNELS TIME CHANNEL CONTROL

This menu allows switching on/off time channels. These channels are used to implement additional

functions and to control external devices. The channels are configured using the Pandora Alarm Studio application.

 **GPS RECEIVER** THIS FUNCTION IS NOT AVAILABLE FOR THE SYSTEM

 **GSM MODEM** THIS FUNCTION IS NOT AVAILABLE FOR THE SYSTEM

 **VALET MODE** SERVICE/VALET MODE

This menu allows enabling/disabling the service (valet) mode (see the “Service mode” section).

 **SETTINGS** SETTING OF THE REMOTE CONTROL

This menu allows configuring the remote control operation.

- **SOUND** — This submenu allows switching on/off sound signals.
- **VIBRO** — This submenu allows switching on/off vibrations.
- **BACKLIGHT** — This submenu allows adjusting LCD backlight brightness.
- **RFM LOST** — This submenu allows configuring sound notifications in case of losing connection between a remote control and a base unit.

 - Disable notification signals

 - Enable notification by “Connection is lost” ringtone

 - Enable notification by “ALARM” ringtone

- **LANGUAGE** - This submenu allows changing interface language of a remote control.
- **WIDGETS** - This submenu allows configuring information about a car state that is displayed in the main screen of a remote control.

 **INFORMATION**

To get technical information about the remote control, select the INFORMATION menu by short presses of the  button and briefly press the  or  button.

RADIO TAG (BT760)

A radio tag is a means of control security and anti-theft functions of the system used for concealed carrying. The radio tag is used to authorize a user in the radio coverage zone of the base unit for such modes as "Immobilizer", "HandsFree", "Slave".

A radio tag has a control button for arming/disarming and switching on and off the service mode. A built-in motion sensor allows the tag to go into energy saving mode when there is no movement. The tag also has a LED indicator SEND.

| |
|--|
| • Control button |
| • Integrated LED SEND indicator |
| • Integrated Bluetooth interface  |
| • Integrated accelerometer |
| • Battery CR 2032 |
| • 2.4 GHz frequency (dialog encryption AES-128) |

Light indication of the SEND indicator when there is a short press of the button:

- No flashes – a battery is discharged
- 1 flash – radio tag operation is correct

Light indication of the SEND indicator when installing a battery:

- No flashes – a battery is discharged
- 1 flash – low battery level
- 3 flashes – high battery level level



WARNING! AVOID MOISTURE ON THE RADIO TAG. DO NOT PLACE THE RADIO TAG NEAR MAGNETS OR PRODUCTS WITH SELF-MAGNETIC FIELDS.

Replacing an immobilizer tag battery

Carefully open the cover of the tag's battery compartment. Extract discharged battery and insert a new one keeping in mind the correct polarity. Replacing a battery will not cause a loss of tag code information, as authorization data is stored in the non-volatile memory of the MCU. Carefully close the cover of the tag's battery compartment. All elements of construction should be rigidly locked in places. If it is so, the tag can be operated as usually.



MOBILE APPLICATIONS

The mobile applications Pandora Online (for Android) and Pandora Pro (for iOS) are additional tools to control the system state. The connection is established only with one phone that was previously paired with the system via a special Bluetooth Low Energy protocol.

**WARNING! MINIMUM REQUIREMENTS FOR MOBILE DEVICES:
PANDORA ONLINE - ANDROID v4.4, BLUETOOTH 4.0 LOW ENERGY;
PANDORA PRO - iOS v10.**

Using the application

Run the application when you are near the system in the Bluetooth radio range. The application will automatically detect your system and will open the main screen with the connected system.

The main screen contains the following information and functions:

- I. MAIN MENU** - provides access to event history, help, system and application settings.
- II. VEHICLE** - displays current status information about the vehicle and system.

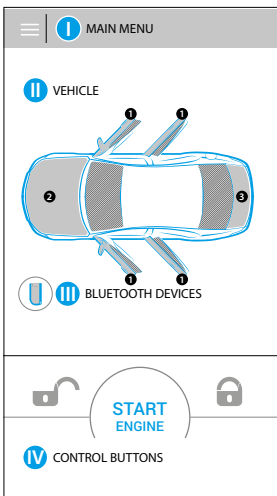

ATTENTION! IF YOU WANT TO CHANGE VEHICLE TYPE OR APPLICATION THEME, GO TO MAIN MENU – SETTINGS – APPLICATION

System modes:

















 - System is armed

 - Service mode is enabled

 - System is disarmed

 - System is in programming mode







Displayed zones:

- | | |
|--|--|
|  - Doors |  - Interior/engine temperature |
|  - Front hood |  - Outside temperature |
|  - Trunk |  - Shock sensor |
|  - Ignition |  - Tilt sensor |
|  - Brake pedal |  - Motion sensor |
|  - Engine is running |  - Additional sensor |
|  - On-board voltage |  - HANDS FREE function state |
|  - Fuel level |  - Siren sound notification state |

III. BLUETOOTH-DEVICES - displays current number and state of recorded Bluetooth radio tags and radio relays.

IV. CONTROL BUTTONS - this panel is used to control a system using buttons. To activate or deactivate a function, press and hold the button for more than 3 seconds (this behavior is implemented to prevent accidentally button presses).

Control buttons:

- | | |
|---|--|
|  - Arm/Disarm buttons |  - PANIC mode button |
|  - Trunk control button |  - Update current state button |
|  - Service mode button |  - Time channel control buttons |
|  - Engine preheater control button | |

NOTE! YOU CAN CHANGE BUTTON LAYOUT IN THE "MAIN MENU – SETTINGS – CONTROL BUTTONS"

Installing the app

Download the mobile app from your device's app store:

- App Store (iOS) – Pandora Pro;
- Google Play (Android) - Pandora Online.

Enter the system programming mode and pair your phone with the system.

Pairing a mobile device

To pair a mobile device, enter the programming mode and go to the programming level №50 "Pairing a mobile device".

Entering the programming mode:

To enter the programming mode, enter the "Service PIN-code" using the VALET button (factory pre-set is "1-1-1-1"). Entering the «Service PIN-code» is similar to entering the «Secret PIN-code» (see the "Control over the system in case of emergency" section).

To proceed to the programming level №50, press and hold the VALET button for 5 seconds until the fifth sound signal of the beeper or the fifth orange flash of the LED).

If a mobile device has been already paired, it will be deleted when you enter this level. When you overwrite the same device in the system memory, you should delete the Bluetooth connection on your mobile device, delete the mobile device from the system memory and then pair the mobile device with the system again.

Pairing a mobile device:

The LED indicator will light green after entering the level. Open the Pandora Online or Pandora Pro mobile application.

• Pandora Online – press the "Bluetooth" icon, press the menu icon in the top right corner and use "Add Bluetooth device" function. The application will search for the system via a Bluetooth connection. Select the found system, the system and the mobile device will be automatically paired.

• Pandora Pro – press the "Bluetooth devices" button in the top right corner and press the "+" icon. The application will search for the system via a Bluetooth connection. Select the found system, the system and the mobile device will be automatically paired.

The system will confirm pairing with the series of green and red flashes of the LED and a sound signal of the siren.

NOTE! IF THERE IS NO AUTOMATIC PAIRING, ENABLE THE "PIN REQUEST FOR PHONE PAIRING" ITEM IN THE "RADIO TAG AND MOBILE DEVICE FUNCTIONS" SETTINGS AND MAKE THE PAIRING PROCEDURE AGAIN. A MOBILE DEVICE WILL REQUEST A PIN-CODE (FACTORY PRE-SET IS 0-0-1-1-1-1 WHERE 4 LAST DIGITS ARE THE "SERVICE PIN-CODE").

Saving changes:

The system will return to the programming level №0 after pairing. Turn on the ignition to automatically save the settings and exit the programming mode.

CONTROL OVER THE SYSTEM

Arming

The system monitors all security zones, locks doors and block the engine when it is armed. If one of the security zones is triggered, the system saves all information in non-volatile memory, activate alarm or warning mode and notifies an owner. If the engine is running when the system is armed and one of the zones is triggered, the system stops the engine. An arming procedure, alarm and warning modes are accompanied by sound and light signals.

The system makes one short sound signal and one flash of the turn lights when arming. If a security zone is triggered when arming, the system will sound 4 beeps instead of 1, turn signals will flash 4 times.

The system turn on sound and turn lights signalization for 30 seconds when it is in alarm mode. You can cancel the signals ahead of time by an arming or disarming command.



The system makes 1 light and 3 sound signals when it is in warning mode.

If one of the zones fails, the system forcibly turns off this zone. If a switch triggers more than 9 times in a row, it will be disabled until the next arming. The shock/tilt/motion sensor is temporarily deactivated for 15 sec. if it has been triggered more than 3 times in a row.

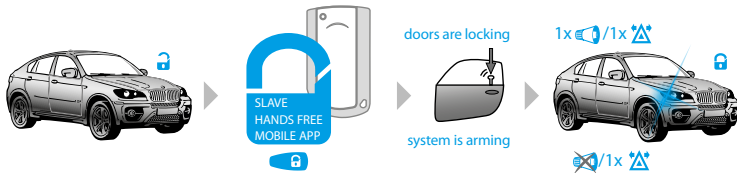
To arm the system when the ignition is off, use one of the methods described below. The system will confirm the command with 1 short sound signal and 1 flash of turn indicators.



Remote control

To arm the system when the ignition is switched off, shortly press  button on the remote control when you are in the radio coverage zone. The remote control will play “ARMING” ringtone and security mode status icon (the lock) will change to .

To arm the system without sound confirmation press and hold  button for 1 second or more.

Radio tag

A radio tag must be in the Bluetooth coverage area. Shortly press the control button on the tag.

SLAVE mode

This mode allows arming using special analog inputs or digital connections to a car. To arm the system, shortly press the “Lock” button on an original remote control or use a sensor/button on a door handle (for cars with an intelligent access system).

NOTE! ADDITIONAL SETTINGS OR CONNECTIONS ARE REQUIRED FOR THIS MODE.

Mobile application

Open the mobile application. When the system is online (you are in the radio coverage area), press and hold the button  on the control panel until the scale is fully loaded.

HandsFree mode

Move with a remote tag (or a paired mobile phone) away from your vehicle .

NOTE! ADDITIONAL SETTINGS ARE REQUIRED FOR USING THE HANDSFREE MODE WITH A MOBILE PHONE.

VALET button

Press and hold the VALET button for 3 seconds. The system will be armed in 30 seconds. The LED indicator is lighting red during the countdown.

NOTE! THERE IS AN OPTION IN THE SYSTEM SETTINGS THAT ALLOWS TO ARM THE SYSTEM WITH DISABLED SENSORS (SHOCK/TILT/ MOTION AND ADDITIONAL SENSORS). THE SETTING “SWITCH OFF SENSORS WHEN ARMING USING VALET BUTTON” IS AVAILABLE IN THE ALARM STUDIO (“MAIN SETTINGS” – “SENSORS SETTINGS”).

Disarming

When the system is disarmed and all additional conditions are met (immobilizer, code immobilizer, additional blocking), the system deactivates engine blocking and provides current state of vehicle zones without saving it to non-volatile memory.

A disarming procedure and triggered zone notifications are accompanied by sound and light signals. The system makes two short sound signals and two flashes of the turn lights when disarming. If a security zone was triggered when the system was armed, the system will sound 4 beeps and turn



signals will flash 4 times.

NOTE! YOU CAN ENABLE “PROHIBIT DISARMING WHEN A TAG IS ABSENT” FUNCTION IN THE SYSTEM SETTINGS. IF THIS MODE IS ENABLED, THE SYSTEM CAN BE DISARMED ONLY IF A TAG IS IN THE RADIO COVERAGE ZONE OR BY ENTERING THE “SECRET PIN-CODE”. THE MODE IS DISABLED BY DEFAULT, USE THE PANDORA ALARMSTUDIO OR MOBILE APP TO ENABLE IT.

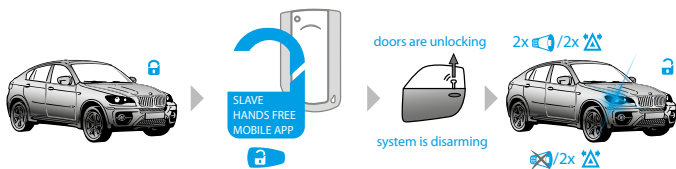
To disarm the system, use one of the methods described below. The system will confirm the command with 2 short sound signals and 2 flashes of turn indicators.



Remote control

To disarm the system, shortly press  button on the remote control when you are in the radio coverage zone. The remote control will play “DISARMING” ringtone and security mode status icon (the lock) will change to .

To arm the system without sound confirmation press and hold  button for 1 second or more.

Radio tag

A radio tag must be in the Bluetooth coverage area. Shortly press the control button on the tag.

SLAVE mode

This mode allows disarming using special analog inputs or digital connections to a car.

To disarm the system, shortly press the “Unlock” button on an original remote control or use a sensor/button on a door handle (for cars with an intelligent access system).

NOTE! ADDITIONAL SETTINGS OR CONNECTIONS ARE REQUIRED FOR THIS MODE.

Mobile application

Open the mobile application. When the system is online (you are in the radio coverage area), press and hold the button  on the control panel until the scale is fully loaded.

HandsFree mode

Move toward the vehicle with a remote tag (or a paired mobile phone) .

NOTE! ADDITIONAL SETTINGS ARE REQUIRED FOR USING THE HANDSFREE MODE WITH A MOBILE PHONE.

VALET button

Enter the "Secret PIN-code" (see the "Emergency disarming using the VALET button" section).

Unlocking a trunk

The system allows you to independently unlock the trunk, no matter if the system is armed or not. If the system is armed when this action is performed, the trunk zone, shock and supplementary sensors will be disabled. All the other security zones will remain armed. If the trunk is not opened in 15 seconds after sending the 'Unlock a trunk' command, the system will enable the sensors and arm the trunk security zone. It will be confirmed with a single flash of turn lights.

To unlock a trunk, use one of the methods described below.

Remote control

To unlock a trunk, press the  button on the remote control and hold it for 1 second (until a sound or vibro signal of the remote control) when you are in the radio coverage zone.

Mobile application

Open the mobile application. When the system is online (you are in the radio coverage area), press and hold the  button on the control panel until the scale is fully loaded.

SLAVE mode

This mode allows unlocking a trunk using special analog inputs or digital connections to a car. To disarm the system, shortly press the "Unlock a trunk" button on an original remote control or use a sensor/button on a trunk (for cars with an intelligent access system).



Locking/unlocking doors when ignition is on

The system allows you to lock and unlock doors when ignition is on. To do this, use one of the methods described below.

Remote control

Press the  button to lock doors or the  button to unlock doors when you are in the radio coverage zone.

Mobile application

Open the mobile application. When the system is online (you are in the radio coverage area), press and hold the  button to lock doors or the button  to unlock doors on the control panel until the scale is fully loaded.

Automatic modes



There is an automatic movement lock mode that will lock the doors at the car movement or on switching on the ignition.



When using doors locking mode on car movement start, the system will detect car moving and perform doors locking (it depends on motion sensor sensitivity settings).

When using doors locking mode on switching on the ignition, the doors will be locked automatically 5 seconds after the ignition was switched on. If any door was opened after the ignition had been switched on, automatic locking will be disabled to prevent locking the keys inside the car

Doors can be automatically unlocked when the ignition is switched off (it depends on system settings).

Delayed arming

If when leaving the car you cannot arm it using a remote control (you have your hands full), you can use delayed arming. To activate this mode, shortly press  and  buttons simultaneously. The LED indicator will turn red, the system will lock doors and will arm in 30 seconds, the siren will sound and turn signals will flash once, indicating that the mode is triggered.

To activate this mode without sound confirmation, press and hold both  and  buttons for 1 second until the sound and vibration signal.

To cancel delayed arming when it is triggered, simply press  button.

Car search function

To easily find your car on a massive parking, shortly press  button when the car is armed. The system will sound the siren and flash turn signals 5 times in a row.

To search for car without sound confirmation, press and hold  button for more than 1 second.

PANIC mode

If your car or you are in danger and you want to draw attention to your car, you can use PANIC mode. In this mode the siren will sound and turn signals will flash repeatedly for 30 seconds. **To activate this mode, use one of the methods described below.**

Remote control

To activate the PANIC mode, press the  and  buttons simultaneously. To switch it off, press either  or  button.

Mobile application

Open the mobile application. When the system is online (you are in the radio coverage area), press and hold the button  on the control panel until the scale is fully loaded.

Remote and automatic engine starts

The system allows for remote engine start using the “remote engine start” command from a remote control, mobile application or preconfigured automatic engine start function. Remote start can be used to heat engine and interior, charge battery or to cool the interior with air conditioning.

Remote and automatic starts can only be used when the system is armed.

If a car has manual transmission, remote or automatic start will only occur if the program neutral procedure was followed when the car was arming.

Remote and automatic engine start on automatic transmission cars will only occur, if a transmission selector lever was left in the «P» position.

When using the remote and automatic engine start functions, make sure that a car is secured with handbrake or some other means of fixing the car on a parking position.

While the system is in remote and automatic start mode, it keeps performing all security functions of all of the security zones excluding a shock sensor (the system can be configured to not disable the shock sensor during remote engine start). To compensate, motion sensor sensitivity and responsiveness will be increased. If any security zone will be triggered, the engine will be immediately stopped and alarm mode will be triggered.

Program neutral procedure (for cars with manual transmission)

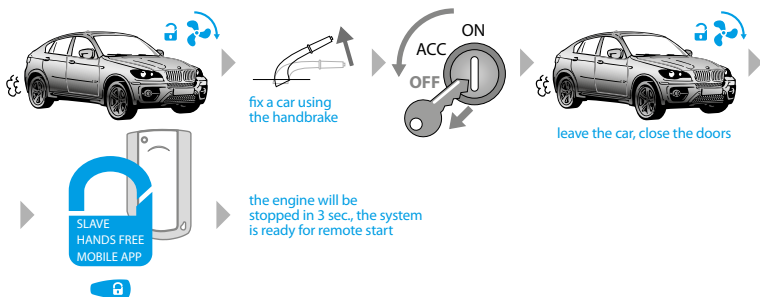

If you are planning to use remote and automatic engine start on a car with manual transmission, before arming you will need to perform following actions:



1. When the engine is running, fixate the car with the handbrake and put gear lever to the neutral position. Program neutral procedure will be switched on automatically.

2. Turn the key in the ignition lock to the OFF position (the engine should still be running) and take it out of the lock.
3. Leave the car, close the doors.
4. Arm the system.
5. The engine will be stopped. Now the system is ready to perform remote and automatic engine start.



Remote engine start

If the system is prepared for remote start, use one of the methods described below to start the engine.

Remote control

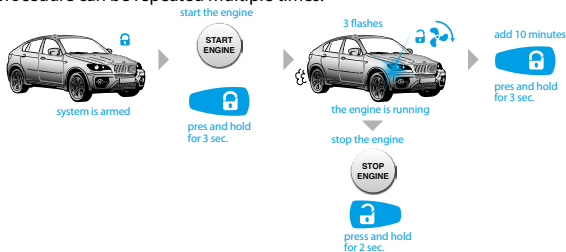
• Press the  button on the remote control and hold it for 3 second (when you are in the radio coverage zone) to start the engine. Sound signal will confirm the command, LCD will show flashing the “engine is running” icon , signifying preparation to the engine start. In a few seconds the engine will be started, the remote will play the “Engine start” ringtone and show spinning engine operation icon. The remote will give notification 1 minute before designated engine stop: the icon  will flash and the “Engine stop in 1 minute” ringtone will play every 10 seconds. Sending the “Remote engine start” command while the “Engine stop in 1 minute” ringtone is playing will extend its operation period by 10 minutes. This procedure can be repeated multiple times.



• To remotely stop the engine while it performs heating, press and hold the  button for 2 or more seconds. The engine will be immediately stopped and it will be confirmed by remote playing the “Engine stop” ringtone and the “Engine is running” icon  fading.

Engine start using an original car key

• Special algorithms detects digital information of a vehicle and allow to start and stop the engine using an original car key.



- An original key must be in radio coverage zone. To start the engine press the LOCK button 3 times within 5 seconds.

NOTE! THE “ENGINE START USING AN ORIGINAL CAR KEY” FUNCTION WORKS WITHOUT ADDITIONAL SETTINGS. AVAILABILITY OF THE FUNCTION DEPENDS ON A SPECIFIC CAR MODEL.

NOTE! ENGINE START PROCEDURE DOESN'T WORK WITHIN 20 SECONDS AFTER ARMING. YOU CAN START THE ENGINE USING AN ORIGINAL CAR KEY AFTER THIS DELAY.

- To stop the engine press the LOCK button 3 times within 5 seconds.

Mobile application

- To start the engine, open the mobile application. When the system is online (you are in the radio coverage area), press and hold the START ENGINE button to start the engine until the scale is fully loaded. The engine will be started in a few seconds, the spinning icon  will confirm engine running.
- To stop the engine, open the mobile application. When the system is online (you are in the radio coverage area), press and hold the STOP ENGINE button to stop the engine until the scale is fully loaded. The engine will be stopped in a few seconds, the spinning icon  will be faded.

Automatic engine starts

The system allows configuring automatic engine start and stop conditions. Automatic starts can be configured using a remote control or mobile application. The following conditions can be specified for automatic engine starts: schedule, time period, engine temperature, voltage. The engine will be stopped automatically after specified time or when the engine temperature reaches a specified value. The engine can be also stopped by a user command.





NOTE! AUTOMATIC ENGINE STARTS AND STOPS BY TEMPERATURE ARE AVAILABLE ONLY IF A TEMPERATURE SENSOR IS CONNECTED. THE SENSOR AVAILABILITY DEPENDS ON THE SYSTEM SET.





SERVICE MODE

It is recommended to put the system into the service mode before handing it to a car service or valet parking. When this mode is switched on, security system stops interfering with built-in electronics and disables all functions to ease maintenance.

To switch on this mode, disarm the system, switch on the ignition, a radio tag must be in the coverage zone, enter the “Immobilizer PIN-code” (if the “Code immobilizer” function is implemented):

Remote control

- To activate service mode, enter the main menu and select the SETTINGS menu using the **F** button. Shortly press the  or  button to enter the SETTINGS menu. Select the SERVICE MODE item using the  or  button. Shortly press the  button to switch on the setting and press the **F** button to confirm.

- To deactivate service mode, enter the main menu and select the SETTINGS menu using the **F** button. Shortly press the  or  button to enter the SETTINGS menu. Select the SERVICE MODE item using the  or  button. Shortly press the  button to switch off the setting and press the **F** button to confirm.

Radio tag

- To activate service mode, press and hold the button on a radio tag for 3 seconds. Release the button after 3 flashes of the LED of the radio tag.

- To deactivate service mode, press and hold the button on a radio tag for 3 seconds. Release the button after 3 flashes of the LED of the radio tag.

Mobile application

- To activate service mode, open the mobile application. When the system is online (you are in the radio coverage area), press and hold the  button to start the engine until the scale is fully loaded.

- To deactivate service mode, open the mobile application. When the system is online (you are in the radio coverage area), press and hold the  button to start the engine until the scale is fully loaded.

NOTE! TO CHANGE BUTTONS LAYOUT OR ADD NEW BUTTONS ON THE CONTROL PANEL, GO TO "SETTINGS → CONTROL BUTTONS".

Immobilizer buttons

- To activate service mode, enter the "Immobilizer PIN-code" and press the immobilizer button 10 times within 20 seconds.

- To deactivate service mode, turn on the ignition and enter the "Immobilizer PIN-code".

Service mode indication

- Activated Service mode is indicated by: an icon in the mobile application, constant green LED when the ignition is on, long sound signal of a Beeper at the moment you activate the mode.

- Deactivated Service mode is indicated by: no "Service mode" icon in the mobile application no constant green LED when the ignition is on, two long sound signal of a Beeper at the moment you activate the mode.

CONTROL OVER THE SYSTEM IN CASE OF EMERGENCY

Emergency disarming

In case you cannot disarm the system using a remote control or immobilizer tag, the 'Secret PIN-code' can be used. The 'Secret PIN-code' is written on the owner's card under the protective layer. The code must be entered only when the base unit is powered and the ignition is off. The PIN-code can be entered using the external or located on the base unit VALET button. The digits input and correct input is indicated by the external or located on the base unit LED indicator.

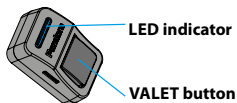

ATTENTION! MAKE SURE THAT THE PROTECTIVE LAYER ON THE OWNER'S PLASTIC CARD IS INTACT AFTER THE INSTALLATION OF THE SYSTEM. THE PLASTIC CARD HOLD THE 'SECRET PIN-CODE'.

ATTENTION! REMOVE THE PROTECTIVE LAYER CAREFULLY. DO NOT USE ANY SHARP OBJECTS TO AVOID DAMAGING OF HIDDEN INFORMATION UNDER THE PROTECTIVE LAYER.

Entering the PIN-code:

Процедура ввода ПИН-кода возможна только при заряженном аккумуляторе и выключенном зажигании. Ввод ПИН-кода выполняется через выносную или расположенную на базовом блоке кнопку «VALET». Отображение ввода кода осуществляется свечением выносного индикатора «LED» или индикатора, расположенного на базовом блоке.

- **ENTER THE FIRST DIGIT** - Press the button the number of times equal to the first digit. Pauses between presses should not exceed 1 second. Each pressing will be confirmed with an orange LED indicator flash. Pause for more than 1 second and a red LED indicator flash confirm the input of the first digit. Then you can enter the next digit.
- **ENTER THE SECOND DIGIT** - Press the button the number of times equal to the second digit. Pauses between presses should not exceed 1 second. Each pressing will be confirmed with an orange LED indicator flash. Pause for more than 1 second and a red LED indicator flash confirm the input of the second digit. Then you can enter the next digit.

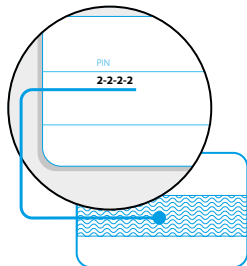

- **ENTER THE THIRD DIGIT** - Press the button the number of times, equals to the third digit. Pauses between presses should not exceed 1 second. Each pressing will be confirmed with an orange LED indicator flash. Pause for more than 1 second and a red LED indicator flash confirm the input of the third digit. Then you can enter the next digit.
- **ENTER THE FOURTH DIGIT** - Enter the fourth digit of the code using the VALET button. Press the button the number of times equal to the fourth digit. Pauses between presses should not exceed 1 second. Each pressing will be confirmed with an orange LED indicator flash. The correct input will be confirmed with the series of green and red flashes of the LED indicator.
 - If the input was correct, the system will be disarmed.
 - If the input was incorrect, it will be indicated with a long red flash of the LED indicator and the system will stay in previous state. New input can be attempted after 5 seconds.
 - If the system was disarmed and the ignition was off, it will enter the programming mode after entering the correct input.

Deactivating/Activating immobilizer radio tags

ATTENTION! IT IS HIGHLY RECOMMENDED TO CHANGE THE FACTORY PRESET OF THE "SERVICE PIN-CODE" FOR IMPROVING SECURITY OF THE SYSTEM.



Write down or remember the "Service PIN-code"

To deactivate immobilizer radio tags, enter the programming level № 15 (the system must be in the programming mode). Enter the 'Secret PIN-code' to disable radio tags or press the VALET button once to enable the tags.

Enter the "Service PIN-code" to enter the programming mode (the factory preset of the service PIN-code is '1-1-1-1'). You can enter the code only if the base unit is powered, the ignition is off, the system is disarmed and the service mode is switched off. If you don't know the 'Service PIN-code', you can enter the programming mode using the 'Secret PIN-code' written on the owner's card. After entering the programming mode, press the VALET button 15 times. Green color of the LED indicator means the radio tags are enabled, red color means the radio tags are disabled.

Deactivate radio tags

The LED indicator will be green after entering the programming level. The system will wait for entering the 'Secret PIN-code'. Enter the 'Secret PIN-code' that is written on the owner's plastic card. The system

will confirm deactivating with two sound signals of the siren and a long red LED flash. After that, the system will return to the programming menu.

If the PIN-code is not entered within 10 seconds or the input is incorrect, the siren will sound one signal, the LED will produce the series of red and green flashes and the system will return to the programming menu. Turn on ignition to exit programming mode.

Activate radio tags

The LED indicator will light red after entering the programming level. The system will wait for action. Press the VALET button once to enable the radio tags. The system will confirm enabling with one short sound signal of the siren and a green LED light. After that, the system will return to the programming menu. Turn on ignition to exit programming mode.

Deactivating code immobilizer (pin-to-drive)

Press the VALET button 13 times to enter the programming level №13 after entering programming mode.

Deactivate code immobilizer:

The LED indicator will be green after entering the programming level. The system will wait for entering the 'Secret PIN-code'. Enter the 'Secret PIN-code' that is written on the owner's plastic card. The system will confirm deactivating with two sound signals of the siren and a long red LED flash. After that, the system will return to the programming menu. If the PIN-code is not entered within 10 seconds or the input is incorrect, the siren will sound one signal, the LED will produce the series of red and green flashes and the system will return to the programming menu. Turn on ignition to exit programming mode.

Activate code immobilizer:

The LED indicator will light red after entering the programming level. The system will wait for action. Press the VALET button once to enable the radio tags. The system will confirm enabling with one short sound signal of the siren and a green LED light. After that, the system will return to the programming menu. Turn on ignition to exit programming mode.

ADDITIONAL INFORMATION

Siren sounds and turn indicators signals

| Signal name | Description |
|---|---|
| Alarm, PANIC mode | Incessant sound and light signals for 30 sec. |
| Arming | 1 sound signal / 1 light signal |
| Disarming | 2 sound signals / 2 light signals |
| 'Sensors triggered' signal when disarming | 4 sound signals / 4 light signals |
| 'Sensors malfunction' signal when arming | 4 sound signals / 4 light signals |
| Warning level of a sensor is triggerd | 3 sound signals |
| Car search | 5 sound signals / 5 light signals |

Beeper sound signals

| Signal name | Description |
|--|---------------------------|
| Activating service mode | 1 sound signal |
| Deactivating service mode | 2 sound signals |
| A battery in a radio tag is discharged | 3 sound signals / 3 times |
| Absence of a radio tag | 4 sound signals / 4 times |
| Blocking warning | Fast sound signals |

LED indicator signals

| Indicator status | Description |
|--|---|
| Short red flashes | System is armed |
| Fast red flashes | Alarm |
| Short green flashes | System is armed (a radio tag is in the coverage zone) |
| Lit red | System is preparing for automatic arming |
| Orange flash | Confirms VALET button press |
| Orange flashes (when switching on the ignition) | Confirms the number of recorded remote controls |
| Green flashes (when switching on the ignition) | Confirms the number of recorded radio tags |
| Red flash (when switching on the ignition) | Confirms a recorded mobile device |
| Red and green flashes | PIN-code is confirmed |
| Faded | System is disarmed |

Checking the number of recorded remote controls/radio tags/mobile device

The number of recorded remote controls/radio tags/mobile device can be checked by the number of orange, green and red flashes of the LED indicator. The number of recorded remote controls/tags/mobile device can be checked when switching on the ignition (the system must be disarmed). The number of orange flashes will indicate the number of recorded remote controls, the number of green flashes will indicate the number of recorded radio tags, a following red flash will indicate mobile device is recorded.

You can also check the number of recorded remote controls/radio tags/mobile device by taking off and putting back on battery terminal. The system will emit short sound signals from a siren with less than 1 sec. interval. The number of the signals equals to the number of recorded remote controls. After a pause of 2 seconds, the system will emit short sound signals from a siren with less than 1 sec. interval. The number of the signals equals to the number of recorded radio tags. After a pause of 2 seconds, the system signal will indicate registered mobile device.

System modules layout

Ask an installer to mark system modules in the picture provided. This information can be important for diagnostics in case of system malfunctions.

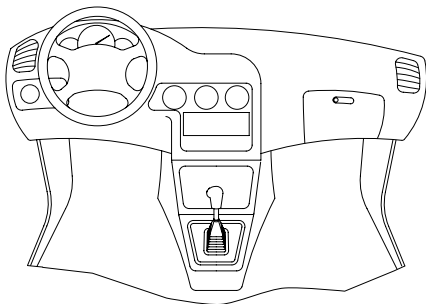

- ① Base unit
- ② VALET button
- ③ Blocking relay

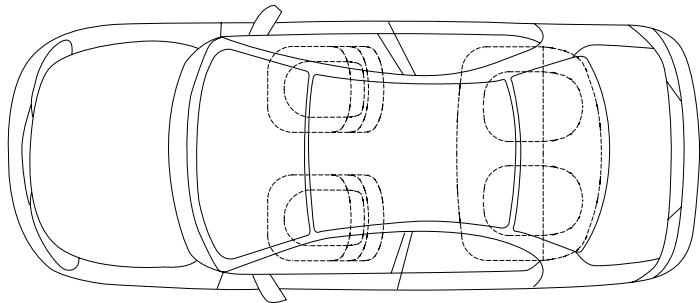

WARRANTY OBLIGATIONS

Manufacturer guarantees correct operation of the service-security system if exploitation, installation, storage and transportation conditions described in this manual were met.

The system should only be used according to installation scheme and user manuals.

The system is meant to be installed by the professional car electronics installers. The installer should fill in installation certificate that is included in this manual.

Parts malfunctioning during warranty period on the fault of the manufacturer should be repaired or replaced by the installation center of the manufacturer or by certified service center. List of certified service centers can be found on pandorainfo.com

The user loses the right for warranty services in the following cases:

- when warranty period expires;
- if exploitation, installation, storage or transportation conditions were not met;
- if there is mechanical damage of the external parts of the system after it is sold.

This includes: fire damage, consequential damage in case of car accident, aggressive liquids and water seeping damage, damage caused by improper use;

- if the damage was caused with incorrect settings and parameter adjustment;
- if system devices are replaced with any devices that are not recommended by the manufacturer;
- if manufacturer sealing is broken;
- if there is no properly filled warranty card and installation certificate.

Warranty period is 3 years since the moment of purchase, but no more than 3,5 (three and a half) years since the moment of production. This warranty does not include batteries of the remotes, as they have their own service lifetime.

Maintenances and repairs of the system with expired warranty period are carried out at the expense of the user on a separate contract between the user and the installer/service center.

WE RECOMMEND YOU TO ASK AN INSTALLER TO FILL OUT THE INSTALLATION CERTIFICATE AND THE WARRANTY CARD. THESE DOCUMENTS MAY BE REQUIRED FOR CONTACTING THE CUSTOMER SUPPORT.

Installation certificate

I, the undersigned _____
Position, name

professional installer, certify that installation of the service-security system, specified below, was carried out by me in accordance with the manuals and schemes provided by the manufacturer.

Car specification:

Car model _____

Type _____

VIN number _____

Registration number _____

Security system specification:

Model **Pandora Light Pro**

Serial number _____

Service center name, full address and installer's stamp _____

Sign _____ / _____
Signator

Work accepted _____ / _____
Signator

Date « » _____ 20 ____ r.

Acceptance certificate

Model **Pandora Light Pro** is in conformity with Electromagnetic Compatibility Directive EMC 2004/108/EC and R&TTE Directive 1999/5/EC.

Serial number _____

Date of production _____

Responsible person's signature (stamp) _____

Packager _____

Signature (personal stamp)

Warranty card

Model **Pandora Light Pro**

Serial number _____

Date of purchase " ____ " _____ 20__y.

Seller's (installer's) stamp

Seller's signature

