

Pandora would like to thank you for choosing our service-security system

Pandora Mini v3 is a car service-security system, built for cars with on-board voltage of 12V.

It is a complex engineering product, which includes unique and modern software and hardware solutions. When building the Pandora Mini v3 we were using the most up-to-date electronics from world's best manufacturers. The device is built using high-precision mounting and control machinery, thus we guarantee highest possible quality, reliability and stable technical characteristics for the whole operation period.

Elegant and advanced technical design and unique ergonomic interaction algorithms that are used in the Pandora Mini v3 allow enhancing your car with fantastic set of intuitive and useful functions.



WARNING! IT IS STRONGLY ADVISED TO HAVE PROFESSIONAL CAR MECHANIC INSTALLING THE SYSTEM. ANY CAR ELECTRONICS INSTALLER SHOULD BE ABLE TO INSTALL THE PANDORA MINI V3 USING INSTALLATION SCHEME IN THIS MANUAL AND ALARM STUDIO SOFTWARE. MOST FEATURES ARE HIGHLY DEPENDENT ON COMPETENT INSTALLATION. OUR SYSTEMS ARE THOROUGHLY TESTED FOR QUALITY, SO IF A FEATURE FAILS TO PRODUCE EXPECTED RESULT, MOST LIKELY THE PROBLEM IS IN IMPROPER INSTALLATION.

This device has limited external factors resistance. It should not be subjected to water beyond occasional splatter, or operated in temperatures outside -40° to +80° C range.

Our web site: www.pandorainfo.com
Customer support: support@pandorainfo.com

Product is in conformity with Electromagnetic Compatibility
Directive EMC 2004/108/EC and R&TTE Directive 1999/5/EC



Table of contents

System set	4
System features	5
Base unit	5
Control and monitoring	5
Arming mode	7
Multi-button code immobilizer	7
Immobilizer mode	8
Anti-Hi-Jack mode	8
Anti-Hi-Jack2 mode	9
Immobilizer radio tag	9
Functions of the button	10
Light indication of SEND LED	10
Replacing an immobilizer tag battery	11
Updating firmware of the tag	11
Mobile applications	12
Using the application	13
Control over the system	16
Arming	16
Disarming	17
Service (VALET) mode	19
Control over the system in case of emergency	20
Emergency disabling immobilizer radio tags	22

System installation	24
Wiring diagram	24
General installation requirements	26
Wiring description	27
System configuration and programming	29
Entering the programming mode	29
Exiting the programming mode	29
Pandora Alarm Studio	30
Programming menu	31
Programming levels table	32
Additional information	40
Siren sounds and light signalizations	40
Beeper sound signals	40
Meaning of the LED indicator colors	41
Checking the number of recorded radio tags	41
Additional devices	42
System module layout	45
Warranty obligations	46
Installation certificate	47
Acceptance certificate	48
Warranty card	48

System set

Base unit	1
Immobilizer tag	2
Blocking relay	1
Cable with VALET button	1
User installation manual	1
Personal owner's card	1
Beeper (compact sound emitter)	1
Main cable	1
Fastening kit	1
Packaging	1

MANUFACTURER RESERVES THE RIGHT TO CHANGE SET AND CONSTRUCTION OF THE PRODUCT TO IMPROVE ITS TECHNOLOGICAL AND OPERATIONAL PARAMETERS WITHOUT NOTIFICATION.

SYSTEM FEATURES

Base unit

- Integrated 2.4 GHz module with support of Bluetooth 5.0
 - Built-in integral accelerometer for deterMini v3ng motion/shock/tilt with adaptive processing algorithm and sensitivity controls
- Built-in micro-USB port
- Integrated temperature sensor (interior temperature)
 - Dialog coding of control commands with 128-bit encryption keys (a key is changed each time an additional device is recorded)
 - Individual “Secret PIN-code”, changeable “Service PIN-code” and “Immobilizer PIN-code”

Control and monitoring

Control of the vehicles zones depends on the type of connection and system settings, original car operation and trim.

Analog connection – It is a direct connection of analog inputs and outputs to electrical circuits of a vehicle in accordance with a connection diagram.

Digital connection – It is a connection to digital (CAN, LIN) buses. It allows reading information (statuses) and controlling vehicles (commands) by digital buses of the vehicles. The detailed information about digital protocols is available on loader.pandorainfo.com. The declared statuses may not be available for certain vehicle trims.

Built-in sensors – These sensors are integrated in the base unit. The sensors perform control and protection of the vehicle. Additional connections are not required

Additional sensor (*optional) – External additional sensors are connected to the base unit.

Analog connection	Digital connection	Built-in sensors	Additional sensors	Guarded and monitored zones
	•	•	•*	Interior temperature (status)
	•		•*	Engine temperature (status)
	•		•*	Outside sensor (status)
		•		Voltage of the on-board circuits (status, security zone – alarm level)
		•		Shock sensor (security zone – alarm and warning level)
		•		Motion sensor (security zone – alarm level)
		•		Tilt sensor (security zone – alarm level)
	•		•*	OE alarm system status via CAN, additional sensor, (status, security zone – alarm and warning level)
•	•			Turning ignition on (status, security zone – alarm level)
•	•			Opening doors, separate indication for each door via CAN (status, security zone – alarm level)
•	•			Opening a trunk (status, security zone – alarm level)
•	•			Pressing brake (status, security zone – alarm level)
•	•			Engine operation control - RPM (status)
•	•			Position of a gearbox selector/handbrake(status)
	•			"Parking light is not turned off" notification
Control (Commands)				
•	•			Central lock
	•			Car original alarm system
•	•			Trunk
•	•			Turn lights
•	•			Closing windows
•	CAN		•*	Engine pre-heaters

Arming mode

The arming mode monitors guarded zones and provides engine blocking. If one of the guarded zones is triggered, the system will record this event in its non-volatile memory, activate the alarm or warning mode and inform an owner with an indication of the zone. If the system is armed, the engine is running, and one of the guarded zones is triggered, the system will stop the engine.

Arming/disarming, alarm mode and warnings are accompanied by sound and light signals. The system confirms arming with 1 sound signal and 1 flash of the turn indicators. The system confirms disarming with 2 short sound signals and 2 flashes of the turn indicators. If one of the guarded zones is opened, the system will produce 4 warning sounds and 4 flashes of the turn indicators at the moment of arming. The system will also produce 4 warning sounds and 4 flashes of the turn indicators at the moment of disarming if there were alarm events during the armed period. The system activates light and sound signals for 30 seconds in the alarm mode. The alarm signals can be canceled by an arming or disarming command. If a warning zone is triggered, the system will produce 1 sound signal and 1 flash of the turn indicators.

If one of the guarded zones fails, the system will forcibly turn off this zone. If a switch triggers more than 9 times in a row, it will be disabled until the next arming. The shock/tilt/motion sensor is temporarily deactivated (15 sec.) if it has been triggered more than 3 times in a row.

Multi-button code immobilizer

Multi-button code immobilizer (pin-to-drive) is a function that allows disarming, disabling blocking and controlling service mode and time channels using original vehicle controls (button, lever or pedal) and a pre-programmed PIN-code (the "Immobilizer PIN-code"). The function works using special analog inputs or digital buses of a car.

An example of using the function:

- Turn on the ignition to disable engine blocking or service mode, turning on the ignition is not required if you want to disarm the system or control time channels.
- Enter the "Immobilizer PIN-code". Press a programmed button/lever/pedal the number of times equals to the first digit. Pauses between presses should not exceed 1 second. More than 1 second pause will be interpreted as the start of the next digit input. The immobilizer code can consist max of 4 digits from 1 to 9.
- The system will confirm the correct input by a sound signal of the beeper and a programmed function will be performed.

NOTE! IT IS REQUIRED TO MAKE ADDITIONAL CONNECTIONS AND SETTINGS TO USE THIS FUNCTION.

Immobilizer mode

When switching on the ignition, a base unit of the security system performs a search for immobilizer tags in radio zone. If no radio tags are detected at the time of switching on the ignition, the system will block the engine. Engine blocking will occur immediately or at the time a motion sensor detects movement, it depends on the system settings.

WARNING! IF THE SYSTEM DOES NOT RECOGNIZE A RADIO TAG, THE BEEPER WILL EMIT 5 SOUND SIGNALS WHEN THE IGNITION IS TURNED ON, THIS WILL REPEAT 5 TIMES. CHECK A RADIO TAG BATTERY, MOVE A TAG (IT GOES TO THE SLEEP MODE WHEN IT REMAINS MOTIONLESS AND THE IGNITION IS OFF. A BUILT-IN ACCELEROMETER HAVE TO RECOGNIZE MOVEMENT TO ACTIVATE A TAG).

NOTE! THIS MODE IS ENABLED BY DEFAULT. USE THE PANDORA BT OR PANDORA ALARM STUDIO TO ENABLE/DISABLE THIS MODE.

Anti-Hi-Jack mode

The Anti-Hi-Jack mode helps to prevent aggressive seizure of a car using delayed engine blocking on door opening. Every time on opening/closing a door when the ignition is on, the system requests a response from a radio tag using a unique algorithm. After a door was opened while the ignition is on, if the system cannot detect a radio tag, the engine will be stopped after 1 minute (general safety requirement). The siren will play the 'ENGINE BLOCKING WARNING' ringtone before blocking. The engine will be blocked immediately or at the time the car starts moving, it depends on system settings. Blocking will be disabled if the system detects a radio tag.

NOTE! THIS MODE IS DISABLED BY DEFAULT. USE THE PANDORA BT OR PANDORA ALARM STUDIO TO ENABLE/DISABLE THIS MODE.

Anti-Hi-Jack 2 mode

The Anti-Hi-Jack-2 mode helps to prevent aggressive seizure of a car using delayed engine blocking on radio tag disappearance. The system constantly requests a response from a tag using a unique algorithm when the ignition is on. If the system cannot detect a radio tag, the engine will be stopped after 1 minute (general safety requirement for car movement). The siren will play the 'ENGINE BLOCKING WARNING' ringtone before blocking. When warning signals end, the system will block the engine. Engine blocking will occur immediately or at the time the car starts moving, it depends on block implementation and system settings.

NOTE! THIS MODE IS DISABLED BY DEFAULT. USE THE PANDORA BT OR PANDORA ALARM STUDIO TO ENABLE/DISABLE THIS MODE.

IMMOBILIZER RADIO TAG

Radio tag is a control device of security and anti-theft functions of the system used for concealed carrying. The tag is used to authorize an user in the radio coverage zone of the base unit for such modes as "Immobilizer", "Hands-Free", "Slave".





The tag has a control button for arming/disarming and switching on and off the service mode. A built-in motion sensor allows the tag to go into energy saving mode when there is no movement. The tag also has a LED indicator "SEND".

- Control button
- Built-in LED indicator "SEND"
- Built-in accelerometer
- Battery CR 2032
- 2.4 GHz radio frequency (dialog encryption AES-128)
- Bluetooth-protocol 



WARNING! IT IS NOT RECOMMENDED TO PLACE THE TAG NEXT TO METAL OBJECTS, MAGNETIC AND ELECTRONIC DEVICES (MAGNETIC AND CREDIT CARDS, PHONES, KEYS, KEY FOBBS, ETC.) FOR CORRECT OPERATION. DO NOT EXPOSE THE TAG TO HIGH TEMPERATURES, MOISTURE. IT IS RECOMMENDED TO PLACE THE TAG ON THE BELT OR IN THE FRONT POCKET OF YOUR CLOTHING

Functions of the button

ACTION	FUNCTION
 - briefly (ignition is off)	Arm/disarm
 - hold for 3 seconds (system is disarmed)	Activate/deactivate Service mode
 - hold for 6 seconds	Pair a tag with the base unit
 - hold for 10 seconds	Firmware update

Light indication of SEND LED

SIGNAL	DESCRIPTION
1 flash	Arming/disarming Confirmation of arming Low battery level (when installing a battery)
2 flashes	Confirmation of disarming
3 flashes	Battery is charged (when installing a battery)
faded	Battery is discharged (when installing a battery, when pressing the button)

Replacing an immobilizer tag battery

Carefully open the cover of the tag battery compartment. Remove a discharged battery and insert a new one keeping in mind the correct polarity.

Replacing a battery will not cause a loss of tag code information, as authorization data is stored in the non-volatile memory of the MCU. Carefully close the cover of the tag battery compartment. All elements of construction should be rigidly locked in places. If it is so, the tag can be operated as usually.



Updating firmware of the tag

- Run the mobile app Pandora BT.
- Press and hold the button on the radio tag until the 10th flash of the **SEND** indicator, then release the button.
- Select the found device in the app and select one of the update option: INTERNET – firmware will be uploaded by an internet connection. FILE MANAGER – firmware will be uploaded from the phone storage (only for Android).

NOTE! АКТУАЛЬНАЯ ВЕРСИЯ ПРОГРАММНОГО ОБЕСПЕЧЕНИЯ ДОСТУПНА НА САЙТЕ [HTTP://PANDORAINFO.COM/](http://pandorainfo.com/) (РАЗДЕЛ ДЛЯ ЗАГРУЗКИ «SUPPORT» → «ALARMSTUDIO & FIRMWARE»).

MOBILE APPLICATIONS

The mobile application Pandora BT for Android and iOS devices is a service application to control and manage the system state via the Bluetooth connection. The mobile device must be paired with the system (see the “Installing the app” section).

NOTE! THE SYSTEM SUPPORTS ONLY ONE MOBILE DEVICE

Installing the app

Download the mobile app from your device's app store:

- App Store (iOS) – Pandora Pro;
- Google Play (Android) - Pandora Online.

Enter the system programming mode and pair your phone with the system

NOTE! MINIMUM REQUIREMENTS FOR MOBILE DEVICES: PANDORA ONLINE - ANDROID v4.4, BLUETOOTH 4.0 LOW ENERGY; PANDORA PRO - IOS v10 .

Enter the system programming mode after installing the app and make the pairing procedure.

Pairing a mobile device

To pair a mobile device:

I. ENTER THE PROGRAMMING MODE

To enter the programming mode, enter the “Service PIN-code” using the VALET button (factory pre-set is “1-1-1-1”). Entering the “Service PIN-code” (see the “Control over the system in case of emergency” section).

II. ENTER THE “PAIRING A MOBILE DEVICE” PROGRAMMING LEVEL

Press and hold the VALET button for 5 seconds until the fifth sound signal of the beeper or the fifth orange flash of the LED). Release the button after the fifth sound signal. The system will enter the “Pairing a mobile device” programming level. The LED indicator will light green after entering the level, it means the system is ready for pairing.

III. PAIR A MOBILE DEVICE

Switch on the Bluetooth on your phone. . Run the Pandora BT app and go to the "Devices -> Searching device" screen. The application will search for the system via a Bluetooth connection. Select the found system ("Pair"), the system and the mobile device will be automatically paired. It will be confirmed with a sound signal of a siren and red and green flashes of the LED indicator.

IV. EXIT THE PROGRAMMING MODE

To finish the pairing procedure, exit the programming mode - switch on the ignition and then switch it off.

NOTE! IF A MOBILE DEVICE HAS BEEN ALREADY PAIRED, IT WILL BE DELETED WHEN YOU ENTER THIS LEVEL. WHEN YOU OVERWRITE THE SAME DEVICE IN THE SYSTEM MEMORY, YOU SHOULD DELETE THE BLUETOOTH CONNECTION ON YOUR MOBILE DEVICE.

NOTE! IF THERE IS NO AUTOMATIC PAIRING, ENABLE THE "PIN REQUEST FOR PHONE PAIRING" ITEM IN THE "RADIO TAG AND MOBILE DEVICE FUNCTIONS" SETTINGS AND MAKE THE PAIRING PROCEDURE AGAIN. A MOBILE DEVICE WILL REQUEST A PIN-CODE (FACTORY PRESET IS 0-0-1-1-1-1 WHERE 4 LAST DIGITS ARE THE "SERVICE PIN-CODE").

Using the application

Run the application when you are near the system in the Bluetooth radio range. The application will automatically detect your system and will open the main screen with the connected system.

NOTE! THE PAIRED MOBILE DEVICE CAN BE USED AS AN OWNER AUTHORIZATION DEVICE FOR THE "IMMOBILIZER", "ANTIHIJACK", "HANDSFREE" MODES. IT IS REQUIRED TO MAKE ADDITIONAL SETTINGS TO ACTIVATE THIS FUNCTION. ENTER THE PROGRAMMING MODE AND CHANGE THE FOLLOWING SETTINGS IN THE MOBILE APP: SETTINGS -> SYSTEM SETTINGS -> HANDS FREE -> MOBILE DEVICE.

The main screen contains the following information and functions:

I MAIN MENU - provides access to event history, help, system and application settings.

II VEHICLE – displays current status information about the vehicle and system.

NOTE! IF YOU WANT TO CHANGE VEHICLE TYPE OR APPLICATION THEME, GO TO MAIN MENU – SETTINGS – APPLICATION.

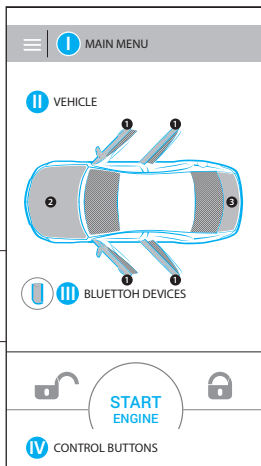

System modes:



System is armed



System is disarmed



Service mode is enabled



System is in programming mode

Vehicle and system statuses:

1

Doors



Shock sensor

2

Front hood



Tilt sensor

3

Trunk









Motion sensor



Ignition









Additional sensor

	Brake pedal		HANDS FREE function state
	Engine is running		On-board voltage
	Siren sound notification state		Fuel level
	Interior/engine temperature		Outside temperature

III BLUETOOTH DEVICES – displays current number and state of recorded Bluetooth radio tags and radio relays.

VI CONTROL BUTTONS – this panel is used to control a system using buttons. To activate or deactivate a function, press and hold the button for more than 3 seconds (this behavior is implemented to prevent accidentally button presses).

Control buttons

	Arm/Disarm buttons		Engine preheater control button
	Time channel control buttons		Trunk control button
	PANIC mode button		Service mode button
	Update current state button		

NOTE! YOU CAN CHANGE BUTTON LAYOUT IN THE “MAIN MENU – SETTINGS – CONTROL BUTTONS”.

CONTROL OVER THE SYSTEM

Arming

To arm the system when the ignition is off, use one of the methods described below. The system will confirm the command receiving with 1 short sound signal and 1 flash of turn indicators.

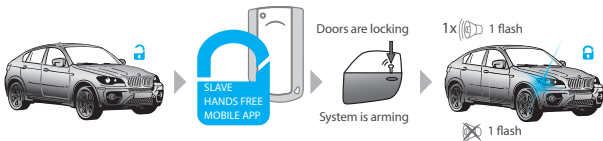

SLAVE mode

This mode allows arming using special analog inputs or digital connections to a car. To arm the system, shortly press the “Lock” button on an original remote control or use a sensor/button on a door handle (for cars with an intelligent access system).

NOTE! ADDITIONAL SETTINGS OR CONNECTIONS ARE REQUIRED FOR THIS MODE.

Mobile application

Open the mobile application. When the system is active, press and hold the button  on the control panel until the scale is fully loaded

Radio tag

A radio tag must be in the Bluetooth coverage area. Shortly press the control button on the tag.

HandsFree mode

Move with a remote tag (or a paired mobile phone) away from your vehicle 

NOTE! ADDITIONAL SETTINGS ARE REQUIRED FOR USING THE HANDSFREE MODE WITH A MOBILE PHONE.

VALET button

Press and hold the VALET button for 3 seconds. The system will be armed in 30 seconds. The LED indicator is lighting red during the countdown.

There is an option in the system settings that allows to arm the system with disabled sensors (shock/tilt/motion and additional sensors). The setting "Switch off sensors when arming using VALET button" is available in the Alarm Studio ("Main settings" – "Sensors settings")

Disarming

To disarm the system, use one of the methods described below. The system will confirm the command receiving with 2 short sound signal and 2 flash of turn indicators.

If there were alarm events during the arming period, siren will sound 4 times and turn signals will flash 4 times.

WARNING! IT IS RECOMMENDED TO USE THE "IMMOBILIZER MODE" AND "PROHIBIT DISARMING WHEN THE TAG IS ABSENT" FUNCTION TO INCREASE ANTI-THEFT PROTECTION.

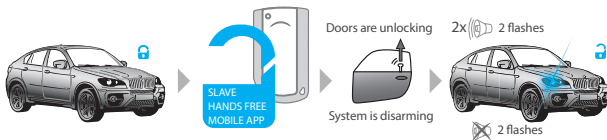

SLAVE mode

This mode allows disarming using special analog inputs or digital connections to a car.

To disarm the system, shortly press the "Unlock" button on an original remote control or use a sensor/button on a door handle (for cars with an intelligent access system).

NOTE! ADDITIONAL SETTINGS OR CONNECTIONS ARE REQUIRED FOR THIS MODE..

Mobile application

Open the mobile application. When the system is active, press and hold the button  on the control panel until the scale is fully loaded.

Radio tag

A radio tag must be in the Bluetooth coverage area. Shortly press the control button on the tag.

HandsFree mode

Move toward the vehicle with a remote tag (or a paired mobile phone) .

NOTE! ADDITIONAL SETTINGS ARE REQUIRED FOR USING THE HANDSFREE MODE WITH A MOBILE PHONE.



VALET button

Enter the "Secret PIN-code" (see the "Emergency disarming using the VALET button" section).

SERVICE (VALET) MODE

It is recommended to put the system into the service mode before handing it to a car service or valet parking. When this mode is switched on, security system stops interfering with built-in electronics and disables all functions to ease maintenance or parking.

To enable this mode, switch on the ignition, a radio tag must be in the coverage zone, enter the "Immobilizer PIN-code" (if the "Code immobilizer" function is implemented) and use one of the methods described below: Switch on/off the service mode using a phone and the Pandora BT application

- To switch on the service mode, open the mobile application. When the system is active, press and hold the button  on the control panel until the scale is fully loaded.
- To switch off the service mode, open the mobile application. When the system is active, press and hold the button  on the control panel until the scale is fully loaded.

NOTE! IN ORDER TO CHANGE BUTTONS LOCATION OR TO ADD A NEW BUTTON ON THE CONTROL PANEL, PROCEED TO THE "SETTINGS" -> "ACTION BUTTONS".

Switch on/off the service mode using a radio tag

- To switch on the service mode, press and hold the button on a radio tag for 3 seconds. Release the button after 3 flashes of the LED of the radio.
- To switch off the service mode, press and hold the button on a radio tag for 3 seconds. Release the button after 3 flashes of the LED of the radio tag.
- Switch on/off the service mode using an immobilizer button
- To switch on the service mode, enter the "Immobilizer PIN-code" and press the immobilizer button 10 times within 20 seconds.
- To switch off the service mode, turn on the ignition and enter the "Immobilizer PIN-code".

Service mode indication

The system will confirm switching on the service mode with:  icon in the mobile application, with a long sound signal of a Beeper and the green LED indicator when the ignition is turned on.

The system will confirm switching off the service mode with: disappearing the  icon in the mobile application, two long sound signals of a Beeper and fading the green LED indicator when the ignition is turned on.

Automatic exit from the service mode

The system can automatically exit the service mode when a vehicle starts moving and when an authorization device is in the coverage zone (radio tag, remote control, mobile device).

NOTE! NO ADDITIONAL SETTINGS ARE REQUIRED FOR THIS FUNCTION. CHECK IF THE "SPEED" FUNCTION IS SUPPORTED FOR YOUR CAR HERE — LOADER.PANDORAINFO.COM.

CONTROL OVER THE SYSTEM IN CASE OF EMERGENCY

Emergency disarming using the VALET button

In case you cannot disarm the system using a phone or immobilizer tag, the 'Secret PIN-code' can be used. The 'Secret PIN-code' is written on the owner's plastic card under the protective layer. The code must be entered only when the base unit is powered and the ignition is off. The PIN-code can be entered using an external or located on the base unit VALET button. The digits input is indicated by an external or located on the base unit LED indicator.

WARNING! MAKE SURE THAT THE PROTECTIVE LAYER ON THE OWNER'S PLASTIC CARD IS INTACT AFTER AN INSTALLATION OF THE SYSTEM. THE PLASTIC CARD HOLDS THE "SECRET PIN-CODE"

WARNING! CAREFULLY REMOVE THE PROTECTIVE LAYER, DO NOT USE SHARP OBJECTS TO AVOID DAMAGING OF HIDDEN INFORMATION UNDER THE PROTECTIVE LAYER.

Entering the PIN-code:

• **ENTER THE FIRST DIGIT** • Press the VALET button the number of times, equals to the first digit. Pauses between presses should not exceed 1 second. Each pressing will be confirmed with an orange LED indicator flash. A pause for more than 1 second and, red LED indicator flash and a short sound signal of the beeper confirms the input of the first digit. Then you can enter the next digit.

• **ENTER THE SECOND DIGIT** • Press the VALET button the number of times, equals to the second digit. Pauses between presses should not exceed 1 second. Each pressing will be confirmed with an orange LED indicator flash. A pause for more than 1 second and, red LED indicator flash and a short sound signal of the beeper confirms the input of the second digit. Then you can enter the next digit.

• **ENTER THE THIRD DIGIT** • Press the VALET button the number of times, equals to the first digit. Pauses between presses should not exceed 1 second. Each pressing will be confirmed with an orange LED indicator flash. A pause for more than 1 second and, red LED indicator flash and a short sound signal of the beeper confirms the input of the first digit. Then you can enter the next digit.

• **ENTER THE FOURTH DIGIT** • Enter the fourth digit of the code using VALET button.

Press the button the number of times, equals to the fourth digit. Pauses between presses should not exceed 1 second. Each pressing will be confirmed with an orange LED indicator flash. After entering the fourth digit:

- If the PIN-code is correct, the system will be disarmed. It will be confirmed with the series of red and green flashes of the LED sound signals of the Beeper, two signals of the siren and two flashes of the light signalization
- If the PIN-cod is incorrect the system will stay in the previous state. New input can be attempted after 5 seconds. Incorrect PIN-code is indicated with a long red flash of the LED.
- If the system was disarmed and the ignition was off, it will enter the programming mode after correct entering the "Secret PIN-code". Turn on the ignition to exit the programming mode.

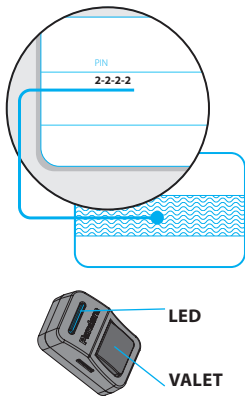

Emergency control of the anti-theft functions

This section describes how to deactivate and activate anti-theft functions (Immobilizer and Anti-Hi-jack), which use a radio tag, a remote control or a mobile phone as an owner authorization device, and “Code immobilizer” function, which uses standard car controls (buttons, levers, pedals) to enter the Immobilizer PIN-code.

Emergency deactivation of anti-theft function

To temporarily deactivate the Immobilizer or Code immobilizer function (pin-to-drive), turn on the ignition when the system is disarmed. Enter the “Secret code” from the owner’s personal card using the VALET button. The immobilizer functions will be being deactivated by the time the ignition is turned off.

Emergency activation/deactivation Immobilizer/Code Immobilizer functions

Emergency control of the anti-theft functions is possible only when the system is disarmed, the ignition is off, service mode is deactivated, a vehicle battery is charged.

Enter the “Secret PIN-code” or the “Service PIN-code” (default value is 1-1-1-1) to put the system in programming mode.

To manage Immobilizer and Anti-Hi-Jack functions - After entering programming mode, press the VALET button 13 times.

To manage Immobilizer and Anti-Hi-Jack functions - After entering programming mode, press the VALET button 15 times.

Pauses between presses should not exceed 1 second. Each pressing will be confirmed with an orange LED indicator flash. The system will confirm entering the 13th level with the red flashes of the LED and short signals of the Siren/Beeper.

• **TO DEACTIVATE THE FUNCTION** – The LED indicator will be green after entering the programming level. The system will wait 10 seconds for entering the ‘Secret PIN-code’. If the PIN-code is not entered within 10 seconds or the input is incorrect, the siren will sound one signal, the LED will produce the series of red and green flashes and the system will return to the programming menu. Enter the ‘Secret PIN-code’ that is written on the owner’s plastic card. The

system will confirm deactivating with two sound signals of the siren, a long red LED flash and two sound signals of the siren. Turn on the ignition and then turn off to exit programming mode. The function will be deactivated.

• **TO ACTIVATE THE FUNCTION** - The LED indicator will light red and the Beeper will sound a long beep after entering the programming level. The system will wait for action. Press the VALET button once activate the immobilizer function. The system will confirm enabling with one short sound signal of the Siren/Beeper and a green LED light. Turn on the ignition and then turn off to exit programming mode. The function will be activated.

Pandora Mini WIRING DIAGRAM

DXL 0110L v3

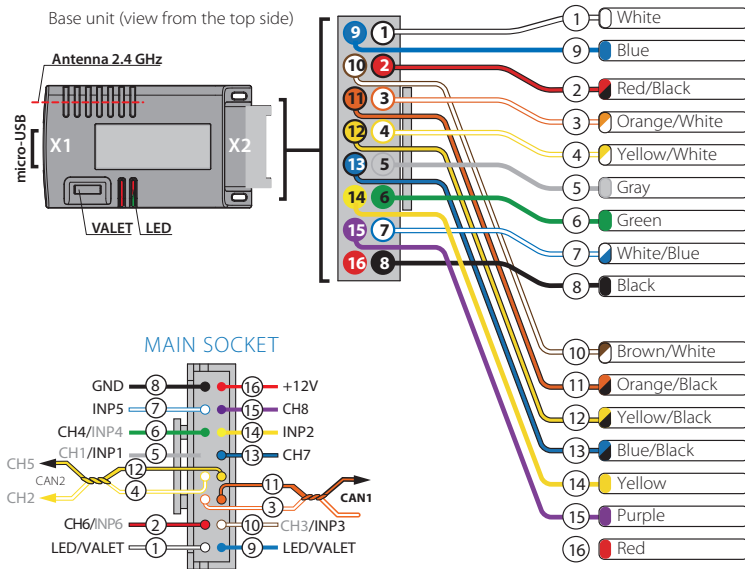

WARNING! Before starting the installation of the system, select a car model in the ALARM STUDIO application (CAN-bus protocol).

WARNING! All power circuits of additional devices that are not powered through base unit of the system should have their own fuses.

WARNING! The security system does not require regular maintenance. In case of malfunction it should be taken to a specialized service center.

WARNING! Do not shield the built-in antennas.

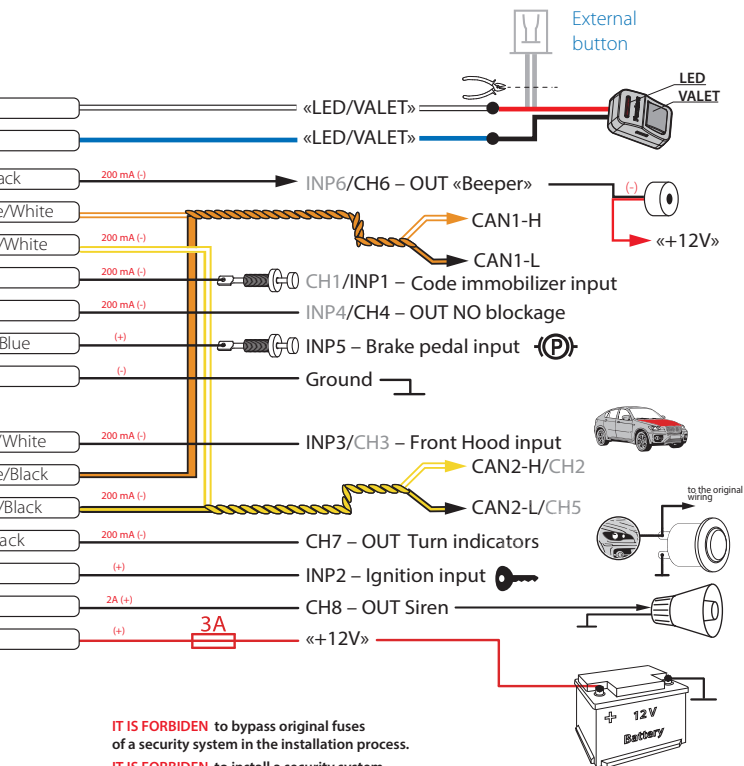

IT IS FORBIDDEN to bypass original fuses of a security system in the installation process.

IT IS FORBIDDEN to install a security system with damaged output cables.

IT IS FORBIDDEN to install the system on a car with normal voltage other than 12V.

SYSTEM INSTALLATION

General installation requirements

- Install the base unit only inside car interior.
- Install securely each system's component, as conditions of the car standard operation can harm functionality of the alarm system and cause damage to the car original systems, including the elements of safety in motion.
- The system installation should be performed when the system sockets and the negative battery terminal are disconnected.
- The base unit power supply should be switched off when connecting to CAN-bus.
- The system installation can be performed via twisting together or via lead-tin soldering followed by isolation of a switching place.
- When wiring, pay attention to sections and materials of switched conductors, if they are different, bring electrochemical potentials to the Mini v3mal difference. The isolation should not allow for moisture to reach wiring, as the presence of moisture will increase electrochemical destruction of wires (this is especially important for the large current circuits).
- Switched connections should be placed as high as it is possible in the cavities so water condensate will not form drops on the switching location.
- To avoid the destruction of compounds by car vibration, ensure that there is a bit of free length to the wiring, providing enough sagging.
- Do not allow wiring in places where the wires isolation can be destroyed by abrasion.
- Electronic system units should be placed sockets down and as high as possible to avoid condensate reaching electronic components through the socket.
- When installing base unit, secure it to the car body for correct operation of in-built shock sensor.
- All unused system wires during the installation must be insulated and secured to prevent accidental touching of a car body or other wires.

Wiring description

Wire №1 (White) — LED/VALET. This wire connects to the red wire of the external VALET button.

Wire №2 (Red-black) 200mA (-) INP6/CH6 — Factory setting is Beeper. This wire connects to the black wire (-) of the sound emitter Beeper. The red wire of the beeper connects to a reliable conductor with constant voltage of +12V.

Wire №3 (Orange-white) CAN1-H — wire of digital bus CAN1-High. It connects to an appropriate CAN-High wire of a car.

Wire №4 (Yellow-white) 200mA (-) CH2/CAN2-H — wire of digital bus CAN2-High. It connects to an appropriate CAN2-High wire of a car. This channel can be assigned as an output, it will not work as a digital bus in this case.

Wire №5 (Gray) 200mA (-) CH1/ INP1 – Factory setting is “Code immobilizer”, see description in the “Programming the immobilizer PIN-code” section.

Wire №6 (Green) 200mA (-) CH4/ INP4 — Factory setting is “NO blockage”. This wire is used to control a blocking relay with a normally open logic. This channel is activated (a relay is closed – blockage is not active) when the system is disarmed, ignition is switched on and a radio tag is in the coverage zone (immobilizer mode).

Wire №7 (White-blue) (+) INP5 — Factory setting is “Brake pedal”, it is a guarded and controlled zone. This wire connects to a brake pedal switch where +12V voltage appears when the pedal is pressed (stop lights wire).

Wire №8 (Black) (-) — Ground. This wire must be connected to the ground of a car. This wire must be connected first during installation.

Wire №9 (Blue) CH3 — LED/VALET. This wire connects to the black wire of the external VALET button.

Wire №10 (Brown-white) 200mA (-) CH3/INP3 — Factory setting is “Front hood”, it is a guarded and controlled zone. This wire connects to appropriate wire that becomes grounded when the front hood opens.

Wire №11 (Orange-black) CAN1-L — wire of digital bus CAN1-Low. It con-

nects to an appropriate CAN-High wire of a car..

Wire №12 (Yellow-black) 200mA (-) CH5/CAN2-L — wire of digital bus CAN2-Low. It connects to an appropriate CAN2-High wire of a car. This channel can be assigned as an output, it will not work as a digital bus in this case.

Wire №13 (Blue-black) 200mA (-) CH7 — Factory setting is "Turn lights". This wire connects to a hazard flashers button of a car.

Wire №14 (Yellow) (+) INP2 — Factory setting is "Ignition" input, it is a guarded and controlled zone. This wire connects to an appropriate wire where 12V voltage appears when ignition is switched on. If there is no ignition status in a CAN-bus, this input must be connected.

Wire №15 (Purple) 2A (+) CH8 — Factory setting is "Siren". It connects to a siren control wire (+).

Wire №16 (Red) (+) — power supply of the system "+12V". It must be connected to a reliable conductor with constant voltage of 12V.

SYSTEM CONFIGURATION AND PROGRAMMING

System settings and parameters can be configured using the Pandora Alarm Studio or Pandora Specialist application. Some functions can be configured only by the programming menu of the system. It is required to put the system to programming mode to get access to the settings.

Entering the programming mode

You can enter the programming mode only if the base unit is powered from USB socket or from an external power supply, the ignition is off, the system is disarmed and the service mode is switched off.

Enter the programming mode by entering the 'Service PIN-code' (factory preset is 1-1-1-1). The PIN-code should be entered using an external or located on the base unit VALET button. The input is indicated by flashes of an external or located on the base unit LED indicator.

The system stops to perform control commands while it is in the programming mode.

NOTE! SEE THE "CONTROL OVER THE SYSTEM IN CASE OF EMERGENCY" SECTION FOR DESCRIPTION OF THE PIN-CODE ENTERING PROCEDURE.

NOTE! IF THERE IS NO 'SERVICE PIN-CODE', YOU CAN ENTER THE PROGRAMMING MODE USING THE 'SECRET PIN-CODE' WRITTEN ON THE OWNER'S CARD

WARNING! IT IS PROHIBITED TO ERASE THE PROTECTIVE LAYER ON THE OWNER'S CARD. THE INFORMATION ON THE CARD IS INTENDED ONLY FOR THE OWNER OF THE SYSTEM.

Exiting the programming mode

There are several ways to exit the programming mode:

Switch on the ignition

Press and hold the VALET button more than 10 seconds (until a siren sound)

Disconnect power of the base unit (disconnect the main power supply and USB)

The system will reboot programmatically (all changes will be saved) after exiting programming mode. All ways to exit the programming menu are accompanied by sound signals of the siren and light signals of the LED indicator. The signals indicate the number of recorded control devices

NOTE! SEE THE "INFORMATION" SECTION FOR DESCRIPTION OF SIGNALS INDICATING THE NUMBER OF RECORDED CONTROL DEVICES

Pandora Alarm Studio

The Pandora Alarm Studio allows configuring the main parameters of the system, uploading firmware updates, downloading installation guides, making the "Pandora CLONE" procedure.

In preparation to programming, these stages should be followed:

- Install the Pandora Alarm Studio to a PC with Windows XP/Vista/7/8/10;
- Start the Pandora Alarm Studio;
- Connect the system and PC via a USB cable;
- Enter the programming mode by entering the service PIN-code;
- The application will automatically open the settings window.

It is recommended to update firmware of the base unit before installing and programming the system (actual version of the firmware you can download from pandorainfo.com or from the Alarm Studio). You can update firmware using the Alarm Studio application after entering the programming mode:

- Press the "Update software" button and select a type of updating;
- "Load from file" – select previously downloaded firmware on your PC, "Firmware archive" - firmware will be downloaded from a server to the "firmwares" folder.
- Select a firmware file and press the "Update" button;

Exit the programming mode after changing the settings or updating firmware.

NOTE! IF AN UPDATING PROCESS HAS BEEN INTERRUPTED FOR SOME REASON AND THE STATUS INDICATOR LIGHTS RED, YOU NEED TO USE THE "QUICK BOOT MODE" TO UPLOAD FIRMWARE. OPEN THE ALARM STUDIO; DE-ENERGIZE AND DISCONNECT THE SYSTEM; PRESS AND HOLD THE VALET BUTTON LOCATED ON THE BASE UNIT; RELEASE THE BUTTON IMMEDIATELY AFTER CONNECTING THE SYSTEM AND A COMPUTER VIA USB CABLE; THE SYSTEM WILL ENTER THE BOOT MODE.

Programming menu

Enter the programming mode, enter the "Service PIN-code" (default value is 1-1-1-1), the system will wait for level input – "Level 0 Entering a level". Enter a desired level using the VALET button (see the "Programming levels table") to change settings or parameters. The system will confirm correct input with red LED flashes and short sound signals of the siren/beeper and proceed to the desired level.

AN EXAMPLE

- To enter a level ("Level №1...№17"), press (**P**) the VALET button the number of times equals to the desired level number (**1...17**), pauses between presses should not exceed 1 second. The system will confirm correct input with red **LED** flashes and short sound signals of the siren/beeper and proceed to the desired level. To enter a sublevel or a cell of sublevel make a pause for more than 1 second (**→**), then press (**P**) the VALET button the number of times equals to the desired sublevel or cell number.
- For quick access to the higher level, press and hold (**H**) the VALET button. The siren will sounds tone beeps (up to 10). These sounds means the sequence number of a two-digit level number (the first signal – level №10, the fifth signal – level №50, the tenth signal – level №100). Release the VALET button immediately after the desired number of signal. To enter an intermediate level (Level №11...№17), press the VALET button the number of times equals to the second digit (**1...7**) of the desired level number immediately after releasing the button. The system will confirm correct input with red **LED** flashes and short sound signals of the siren/beeper and proceed to the desired level.

Programming levels table

Function	VALET button		
Nº0 – Entering a level	Level	Erase	Update
Nº1 – Pairing a remote control D030/Watch2	P1	H3	
Nº2 – Changing the Service PIN-code	P2		
Nº3 – Recording the idle speed (rpm)	P3		
Nº4 – Reset to the factory settings	P4	H4	
Nº10.1.1 – Pairing a radio tag BT760/BT770	H1→P1→P1	H3	
Nº10.1.1 – Pairing a radio tag BT760/BT770	H1→P1→P2	H3	
Nº10.1.1 – Pairing a radio tag BT760/BT770	H1→P1→P3	H3	
Nº10.3.1 – Pairing a door sensor DMS-100 BT	H1→P3→P1	H3	H5
Nº10.3.1 – Pairing a door sensor DMS-100 BT	H1→P3→P2	H3	H5
Nº10.3.1 – Pairing a door sensor DMS-100 BT	H1→P3→P3	H3	H5
Nº10.3.1 – Pairing a door sensor DMS-100 BT	H1→P3→P4	H3	H5
Nº10.4.1 – Pairing a radio relay BTR-101	H1→P4→P1	H3	H5
Nº10.4.1 – Pairing a radio relay BTR-101	H1→P4→P2	H3	H5
Nº10.5 – Pairing a mobile phone	H1→p5		
Nº10.6 – Pairing an engine compartment module RHM-03BT/PS-331BT/PS-332BT	H1→P6	H3	H5
Nº10.7 – Pairing an additional device DI-04 or BT-01	H1→P7	H3	H5
Nº10.8 – Pairing a telemetry module Pandora Eye Pro / NAV-X	H1→P8	H3	

Nº10.9 – Pairing a GPS-receiver NAV-035 BT	H1→P9	H3	H5
Nº10.10 – Updating Bluetooth modem firmware	H1→P10		
Nº10.11 – Pairing an RF module RFM-470	H1→P11	H3	H5
Nº11 – Programming and configuring an “Immobilizer PIN-code”	H1•P1		
Nº13 – Emergency deactivating/activating code immobilizer function (pin-to-drive)	H1•P3		
Nº15 – Emergency deactivating/activating authorization devices (immobilizer, anti-hi-jack)	H1•P5		
Nº17 – Programming bypass of an original immobilizer	H1•P7		
Nº50 – Pairing a mobile phone	H5		
Nº100 – Exit the programming menu	H10		

Control by the VALET button (see the “Level Nº0 Entering a level” section)

P – press **X** times
→ – 1 sec. pause

H – hold for **X** sec.
• – without a pause

NOTE! THE ADDITIONAL DEVICES THAT ARE INCLUDED IN THE SYSTEM SET HAVE BEEN ALREADY RECORDED IN THE SYSTEM MEMORY (SEE THE “SYSTEM SET” SECTION OF THE USER MANUAL).

Level №1 – Pairing a control device D030/Watch2

Only one control device can be paired on this level.

Prepare to pair a Bluetooth device, turn the device on in accordance with its manual. The system will be in the remote controls pairing mode for 1 minute. After a minute or immediately after pairing a Bluetooth remote control, the system will automatically enter the programming level №0.

The LED indicator will show state of the memory cell: Green light means the cell is empty and the system is ready for pairing; red light means the cell is occupied, it is required to delete the current device to pair a new one. Press and hold the VALET button for 3 seconds until the fourth orange flash of the LED to remove the previously paired device.

An example of pairing a D030 remote control:

- Enter the programming level №1.
- If the LED is green, the system is ready for pairing.
- Press and hold 3 buttons of a remote control (arm/disarm/F) simultaneously for 1 second (until a short beep), then release the buttons.
- If pairing was successful, the LED will be red, the siren/beeper will sound a beep. The system will enter the programming level №0.

An example of pairing a Watch2:

- Enter the programming level №1.
- If the LED is green, the system is ready for pairing.
- Go to the MENU -> Settings -> Bluetooth -> Car -> Pair in the Watch2 menu and wait for pairing.
- If pairing was successful, the LED will be red, the siren/beeper will sound a beep. The system will enter the programming level №0.

Level №2 – Changing the factory preset of the service PIN-code

Prepare a new value of the 'Service PIN-code', it should consist of 4 digits (from 1 to 9). Write down or remember the new PIN-code.

The system will enter 'Changing the Service PIN-code' mode and the status LED indicator will turn off after entering the level.

Changing the 'Service PIN-code':

- Enter the first digit of the code using the VALET button. Press the button a number of times, equals to the first digit. Pauses between presses should not exceed 1 second, every pressing will confirm with an orange LED indica-

tor flash. A pause for more than 1 second and red LED indicator confirms the input of the first digit. Then you can enter the next digit;

- Enter the other numbers in the same manner. The input of the fourth number will be confirmed by the series of red and green LED indicator flashes. The system will wait for PIN-code re-entering;
- Enter all four digits again;
- If you were able to correctly enter the 'Service PIN-code' twice, the indicator will produce the series of red and green flashes, the new PIN-code will be recorded, the system will return to programming mode.
- In case of the incorrect code input the indicator will be lit red, the system will return to the programming mode.

Level №3 – Recording the idle speed (rpm) to the system memory

To timely turn off the starter during automatic or remote engine start via digital or analog tachometer input and the correct operation of the 'Smart Turbo Timer', it is necessary to record the engine idle speed.

Switch on the ignition and start the engine after entering this level of programming (the engine should be warmed-up; idle speed should match the stable idle speed of the warmed-up engine). The system will confirm the presence of the idle speed status with green flashes of the LED indicator. Wait until the stable idle speed will be reached and save the changes by pressing the VALET button. Successful recording of the idle speed will be confirmed with the series of red and green flashes of LED indicator and a siren signal. The series of siren signals will indicate incorrect recording. The system will exit the programming menu and reboot after saving the idle speed.

Level №4 – Resetting to the factory settings

The procedure recovers the factory settings of the system without deleting previously registered devices (remote controls, tags, mobile device, relays, etc.) that is stored in the non-volatile memory.

Press and hold the VALET button for more than 4 seconds until a siren signal, then release the button. The system will confirm resetting to the factory settings with a long red flash of the LED indicator. After that the system will return to the programming mode.

Level №10 – Manage Bluetooth devices/Updating Bluetooth modem firmware

This level is used to pair/remove/update additional devices and to update Bluetooth modem of the system.

ATTENTION! ALL FUNCTIONS OF THIS LEVEL ARE AVAILABLE IN THE PANDORA SPECIALIST APP WITHOUT ENTERING THE LEVEL №10. GO TO THE “ADVANCED MOUNTING” -> “SYSTEM DEVICES” TO PAIR/DELETE AND UPDATE ADDITIONAL DEVICES. GO TO THE “ADVANCED MOUNTING” -> “CHECK UPDATES” TO UPDATE SYSTEM FIRMWARE.

MANAGE BLUETOOTH DEVICE

Each device is paired at a sublevel. To pair devices of the same type, a sublevel is divided into cells. To enter a sublevel or a cell of sublevel make a pause for more than 1 second (→), then press (P) the VALET button the number of times equals to the desired sublevel or cell number.

Each sublevel or cell displays its current state by a color of the LED: green light means the system is ready for pairing, red light means a device has been already paired and it is required to delete it for pairing a new device. To delete a device, press and hold the VALET button for 3 seconds (4 orange flashes of the LED). The system will be in pairing mode for 1 minute. After a minute or immediately after pairing a device, the system will automatically enter the programming level №0

An example of pairing radio tags BT760/BT770:

- Enter the programming level №10.1.1...3.
- If the LED is green, the system is ready for pairing.
- Press the control button on a tag and hold it for 6 seconds (6 flashes of the tag status indicator), release the button after the sixth flash.
- If pairing was successful, the LED will light red and the siren/beeper will sound a beep. The system will enter the programming level №0.

An example of pairing door sensor DMS-100 BT:

- Enter the programming level №10.3.1...4.
- If the LED is green, the system is ready for pairing.

- Open the plastic case of the sensor carefully and insert a battery into the sensor.
- If pairing was successful, the LED will light red and epy siren/beeper will sound a beep. The system will enter the programming level №0.

An example of pairing a radio module RHM-03 BT:

- Connect the wire 4 (Green) to wire 5 (Black). Connect them to ground (-).
- Enter the programing level №10.6 – “Pairing an engine compartment module”. The LED will light green or red
- Connect the wire 7 (Red) to +12V.
- If pairing was successful, the LED will light red and a siren/beeper of the base unit will sound a beep. The system will automatically enter the programming level №0.
- Disconnect the wire 4 (Green) from the wire 5 and insulate all unused wires.

An example of pairing a radio relay BTR-101:

- Connect the wire 1 (GROUND) to a grounded spot of a car.
- Enter the programing level №10.4.1 or №10.4.2.
- If the LED is green, the system is ready for pairing*.
- Connect the wire 3 (PROGRAMMING) to wire 4 (+12V POWER SUPPLY). Connect them to +12V.
- If pairing was successful, the LED will light red and the siren/beeper will sound a beep. The system will enter the programming level №0.
- Disconnect the wire 3 (PROGRAMMING) from the wire 4 and insulate all unused wires. Connect the wire 4 to the ignition (+12V when ignition is on).

UPDATING FIRMWARE OF THE BUILT-IN BLUETOOTH MODEM/UPDATING FIRMWARE OF AN ADDITIONAL DEVICE

To update firmware of the built-in Bluetooth modem, enter the “Level №10” → “Sublevel 10”. To update firmware of an additional device, enter the “Level №10” → “Sublevel” or “Cell” corresponding to an additional device. The LED will light red after entering. Press and hold (H) the VALET button for 6 seconds. Open the Pandora Specialist, go to “Search device” screen and select the device and then select one of the update option:

INTERNET – It allows you to upload firmware from a server.

FILE MANAGER – This function is available only for Android devices. It allows you to upload firmware from phone storage.

Level №11 – Programming the “Immobilizer PIN-code”

The level is divided into 3 sublevels (Sublevel 11.1 – Selecting buttons; sublevel 11.2 entering the PIN-code; sublevel 11.3 – confirmation of the PIN-code input).

The system will automatically enter the sublevel 11.1 (Selecting buttons) after entering the level 11. The VALET button is used to proceed to the next sublevels and to save the “Immobilizer PIN-code”

• №11.1 - Selecting buttons

The system will wait for pressing buttons after entering this sublevel. Each pressing of an active button will be indicated by an orange flash of the LED. You can turn on the ignition on this sublevel, the system will not exit the programming mode (some buttons are active only when ignition is on). The system can determine active buttons via a digital bus of a car or via a ‘Code Immobilizer’ analog input.

• №11.2 - Entering the PIN-code

This sublevel is used to program the immobilizer deactivation PIN-code using the selected buttons. The code can consist of one or more memory cells, each memory cell can store a sequence of pressing each of the five selected immobilizer buttons.

The code is entered by pressing the selected buttons for at least 1 second. Each pressing is confirmed with an orange flash of the LED. A pause for more than 1 second and the red LED confirms the input for the current memory cell, you can start entering the next memory cell.

• №11.3 - Confirmation of the PIN-code input

Confirm the entered PIN-code on this level. Repeat the procedure described above. The system will compare two inputs after that.

- The system will confirm the correct PIN-code with red and green flashes of the LED indicator and will memorize the PIN-code, and then the system will proceed to the programming mode awaiting level input.

- Incorrect confirmation is indicated with a long red flash of the LED indicator, the system will cancel the input and return to the programming mode.

Level №13/№15 – Emergency deactivating/activating authorization devices/functions

NOTE! SEE THE DETAILED DESCRIPTION IN THE “CONTROL OVER THE SYSTEM IN CASE OF EMERGENCY” SECTION OF THE USER MANUAL.

Level №50 – Pairing a mobile phone

NOTE! SEE THE DETAILED DESCRIPTION IN THE “MOBILE APPLICATIONS” SECTION OF THE USER MANUAL.

Level №100 – Exit the programming menu

To exit the programming menu, press and hold the VALET button for more than 10 seconds until the tenth sound signal of the Siren/Beeper or until a red flash of the LED. The system will exit programming mode and will reboot programmatically.

INFORMATION

Siren sound and turn indicators signals

Signal	Description
Alarm, PANIC mode	Incessant sound and light signals for 30 sec
Arming	1 sound and 1 light signals
Disarming	2 sound and 2 light signals
'Sensors triggered' signal when disarming	4 sound and 4 light signals
'Sensors malfunction' signal when arming	4 sound and 4 light signals
Warning level of a sensor is triggered	3 sound signals
Car search	5 sound and 5 light signals

Beeper sound signals

Signal	Description
Enable the Service mode	1 sound signal
Disable the Service mode	2 sound signals
A battery in a radio tag is discharged	3 sound signals / 3 times
Absence of a radio tag	5 sound signals / 5 times
Blocking warning	Fast sound signals

Meaning of the LED indicator colors

Indicator status	Description
Short red flashes	System is armed
Fast red flashes	Alarm
Fast green flashes	System is armed (a radio tag is in the coverage zone)
Lit red	The system is preparing for automatic arming
Orange flash	Confirms VALET button press
Orange flashes (when switching on the ignition)	Confirms the number of recorded remote controls
Green flashes (when switching on the ignition)	Confirms the number of recorded radio tags
Red flash	
(when switching on the ignition)	Confirms the recorded mobile device
Red and green flashes	PIN-code is confirmed
Faded	The system is disarmed

Checking the number of recorded radio tags/mobile device

The number of recorded remote controls/radio tags/mobile device can be checked by the number of green and red flashes of the LED indicator. The number of recorded remote controls/tags/mobile device can be checked when switching on the ignition (the system must be disarmed). The number of green flashes will indicate the number of recorded radio tags, a following red flash will indicate a mobile device is recorded.

You can also check the number of recorded tags and registered mobile device by taking off and putting back on battery terminal. The system will emit short sound signals from a siren with less than 1 sec. interval. The number of the signals equals to the number of recorded radio tags. After a pause of 2 seconds the system signal will indicate registered mobile device.

Addition devices

Radio tag BT-770/BT-760:

- Integrated 2.4 GHz radio interface (Bluetooth 4.2 Low Energy protocol)
- Built-in accelerometer
- Built-in control button
- Built-in LED
- CR 2032 battery



Remote control D030

- OLED-display
- 3 control buttons
- Built-in sound indicator
- Built-in vibro-indicator
- Built-in LED indicator «ALARM/SEND»
- Integrated 2.4 GHz radio interface (Bluetooth 4.2 Low Energy protocol)
- Built-in battery
- Built-in micro-USB port



Blocking radio relay BTR-101

Radio relay BTR-101 is an additional Bluetooth device designed to increase the system security features. The device has small dimensions and works with the system via a secure radio channel, which allows for concealed installation. The relay provides additional protection against mechanical and electronic hacking for a vehicle.

Main features:

Blocking controlled by the system and autonomous blocking in case of unauthorized movement.

Application and operating principle:

The power supply and circuit to be blocked are connected to the relay. The system control the relay via a radio channel.



Radio module of engine compartment RHM-03 BT

This module is designed to simplify the system installation and wiring in the engine compartment module. The device has small dimensions and works with the system via a secure radio channel, which allows for concealed installation. The module provides additional protection against mechanical and electronic hacking for a vehicle.

Main features:

Blocking controlled by the system and autonomous blocking in case of unauthorized movement; controlling front hood locks, siren and digital control of Eberspaehar and Webasto engine preheaters; The module also sends the following information to the base unit: temperature, hood switch status, engine preheater status

Application and operating principle:

The module is installed discreetly in the engine compartment. It has a temperature sensor, built-in normally closed relay, "opening/closing hood lock" outputs, siren output, digital LIN output for an engine preheater, hood switch input.



Door sensor DMS-100 BT

DMS-100 BT is an additional Bluetooth device designed to increase the system security features. The device has small dimensions and works with the system via a secure radio channel, which allows for concealed installation without additional power supply connections.

Main features:

The sensor sends the following information to the base unit: detection of shock and rotation, Hall effect sensor triggers, temperature.

Application and operating principle:

The sensor can be installed on wagon, trailer doors. It has its own power source.



Telemetry modules Pandora Eye Pro and NAV-X

Additional devices designed to extend the system function with telemetric and service functions by GSM and the Internet connection:

- GSM, phone calls
- pandora-on.com - online service
- Pandora Pro (iOS), Pandora Online (Android) – special mobile applications for smartphones, tabs and smartwatches Apple Watch, Android Wear, Samsung Gear S2/S3

MANAGE

Arming/Disarming | Trunk | Service mode | Engine Blocking

CONTROL

Vehicle and system statuses | GPS-location | Tracking | "Listening" function

NOTIFICATIONS

Voice | SMS | PUSH | E-mail

GSM-MODEM (GPRS/SMS/LBS) | NANO-SIM | GPS/GLONASS-RECEIVER | BLUETOOTH INTERFACE | MICROPHONE | +12V POWER SUPPLY | BACK-UP BATTER (ONLY FOR PANDORA EYE PRO) | MICRO-USB



System modules layout

Ask an installer to mark system's modules on the picture provided. This information can be important for diagnostics in case system malfunctions.

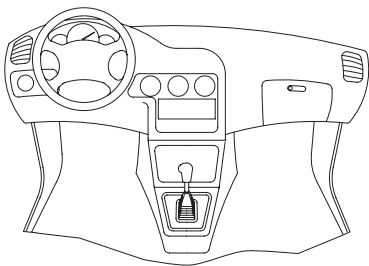

- 1 Base unit
- 2 VALET button
- 3 Blocking relay

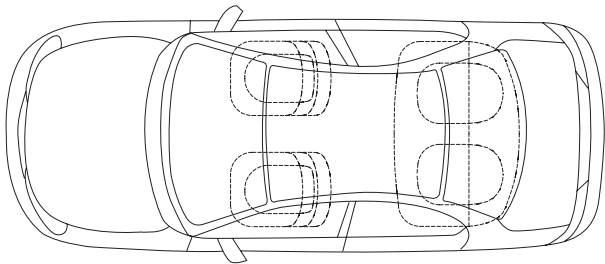

WARRANTY OBLIGATIONS

WARNING! WE RECOMMEND YOU TO ASK AN INSTALLER TO FILL OUT THE INSTALLATION CERTIFICATE AND THE WARRANTY CARD. THESE DOCUMENTS MAY BE REQUIRED FOR CONTACTING THE CUSTOMER SUPPORT

Manufacturer guarantees correct operation of the service-security system if exploitation, installation, storage and transportation conditions described in this manual were met. The system should only be used according to installation scheme and user manuals.

The system is meant to be installed by the professional car electronics installers. The installer should fill in installation certificate that is included in this manual. Parts malfunctioning during warranty period on the fault of the manufacturer should be repaired or replaced by the installation center of the manufacturer or by certified service center. List of certified service centers can be found on pandorainfo.com

The user loses the right for warranty services in the following cases:

- when warranty period expires;
- if exploitation, installation, storage or transportation conditions were not met;
- if there is mechanical damage of the external parts of the system after it is sold.

This includes: fire damage, consequential damage in case of car accident, aggressive liquids and water seeping damage, damage caused by improper use;

- if the damage was caused with incorrect settings and parameter adjustment;
- if system devices are replaced with any devices that are not recommended by the manufacturer;
- if manufacturer sealing is broken;
- if there is no properly filled warranty card and installation certificate.

Warranty period is 3 years since the moment of purchase, but no more than 3,5 (three and a half) years since the moment of production. This warranty does not include batteries of the remotes, as they have their own service lifetime.

Maintenances and repairs of the system with expired warranty period are carried out at the expense of the user on a separate contract between the user and the installer/service center.

Installation certificate

I, the undersigned _____
Position, name

professional installer, certify, installation of the service-security system, described below was carried out by me according to manuals and schemes provided by the manufacturer.

Car specifications:

Car model _____

Type _____

ID number (VIN) _____

Registration number _____

Security system specifications:

Model **Pandora Mini v3**

Serial number _____

Service center name, full address and installer's stamp _____

Signature _____ / _____ /

Signator

Work accepted _____ / _____ /

Signator

Date " ____ " _____ 20__ y

Acceptance certificate

Pandora Pandora Mini v3 is in conformity with Electromagnetic Compatibility Directive EMC 2004/108/EC and R&TTE Directive 1999/5/EC.

Serial number _____

Date of production _____

Responsible person's signature _____

(stamp)

Packager _____

Signature (personal stamp)

Warranty card

Model **Pandora Pandora Mini v3**

Serial number _____

Date of purchase « ____ » _____ 20__ year

Seller's (installer's) stamp

Seller's signature _____